



BOTSWANA • CONGO • KENYA • MALAWI • NAMIBIA • SEYCHELLES • SOUTH AFRICA • ZAMBIA • ZIMBABWE



WILDERNESS SAFARIS

PRODUCT PORTFOLIO
Version 4

OUR PRESENCE IN AFRICA



BOTSWANA

CAMPS

Abu Camp	Little Mombo
Banoka Bush Camp	Little Tubu
Chitabe Camp	Little Vumbura
Chitabe Lediba	Mombo Camp
Duba Plains	Savuti Camp
DumaTau Camp	Seba Camp
Jacana Camp	Selinda Camp
Jao Camp	Tube Tree Camp
Kalahari Plains Camp	Vumbura Plains
Kings Pool	Xigera Camp
Kwetsani Camp	Zarafa Camp

KENYA

CAMP

Segera Retreat

MALAWI

CAMPS

Chelinda Camp	Mumbo Island
Chelinda Lodge	Mvuu Camp
Chintheche Inn	Mvuu Lodge

NAMIBIA

CAMPS

Andersson's Camp	Little Kulala
Damaraland Camp	Little Ongava
Desert Rhino Camp	Ongava Lodge
Doro Nawas Camp	Ongava Tented Camp
Hoanib Skeleton Coast	Serra Cafema Camp
Kulala Desert Lodge	

REPUBLIC OF CONGO

CAMPS

Lango Camp
Ngaga Camp

SEYCHELLES

CAMP

North Island

SOUTH AFRICA

CAMPS

Pafuri Camp
Rocktail Beach Camp

ZAMBIA

CAMPS

Busanga Bush Camp	The River Club
Kalamu Lagoon Camp	Toka Leya Camp
Shumba Camp	

ZIMBABWE

CAMPS

Little Makalolo	Ruckomechi
Davison's Camp	



CONTENTS

ABOUT WILDERNESS SAFARIS	2	NAMIBIA	58
WHY TRAVEL WITH WILDERNESS SAFARIS?	3	Little Kulala.....	62
DESIGNING YOUR SAFARI	5	Kulala Desert Lodge	63
SUGGESTED ITINERARIES.....	9	Damaraland Camp	64
Botswana.....	7	Doro Nawas Camp	65
Namibia	8	Desert Rhino Camp	66
Zimbabwe	9	Hoanib Skeleton Coast	67
Zambia	9	Serra Cafema Camp	68
Malawi.....	10	Little Ongava	69
South Africa.....	11	Ongava Tented Camp	70
Kenya.....	11	Ongava Lodge	71
Congo	12	Andersson's Camp	72
CHOOSING YOUR CAMPS.....	14	SEYCHELLES	74
BOTSWANA	16	North Island	76
Mombo Camp	20	SOUTH AFRICA.....	78
Little Mombo	21	Pafuri Camp	80
Vumbura Plains.....	22	Rocktail Beach Camp	81
Little Vumbura	23	ZAMBIA.....	82
Duba Plains	24	Shumba Camp	84
Jao Camp	25	Busanga Bush Camp.....	85
Jacana Camp	26	Kalamu Lagoon Camp	86
Kwetsani Camp	27	The River Club.....	87
Tubu Tree Camp	28	Toka Leya Camp	88
Little Tubu.....	29	ZIMBABWE.....	90
Abu Camp	30	Little Makalolo Camp.....	92
Seba Camp	31	Davison's Camp	93
Xigera Camp	32	Ruckomechi Camp	94
Chitabe Camp	33	WILDERNESS EXPLORATIONS	96
Chitabe Lediba.....	34	The Great Wilderness Journey.....	97
Banoka Bush Camp.....	35	Migration Routes	98
Kings Pool.....	36	Botswana Summer Encounter.....	99
DumaTau Camp.....	37	Green Desert Expedition.....	100
Savuti Camp	38	Selinda Canoe Trail	101
Zarafa Camp	39	The Great Namibian Journey	102
Selinda Camp	40	Diverse Namibia	103
Kalahari Plains Camp	41	Rift Valley Explorer.....	104
CONGO.....	42	Landscapes of Malawi	105
Lango Camp.....	44	Pafuri Walking Trail	106
Ngaga Camp	45	Mana Canoe Trail	107
KENYA	46	WILDERNESS AIR	108
Segera Retreat.....	48	WILDERNESS TOURING	118
MALAWI	50	WILDERNESS SAFARIS PARTNER PRODUCT	121
Mvuu Lodge.....	52	MORE THAN JUST A SAFARI.....	122
Mvuu Camp	53	INDEX.....	124
Mumbo Island Camp.....	54		
Chintheche Inn	55		
Chelinda Lodge.....	56		
Chelinda Camp.....	57		

ABOUT WILDERNESS SAFARIS

In short...

OUR VISION

A wilderness that inspires positive action.

OUR MISSION STATEMENT

We **exist** as we believe that the world's wilderness areas will save humankind.

Our **aim** is to get to understand the wilderness better, to respect it, care for it and share it.

Our **quest** is to offer our guests the most original journeys and experiences.

Our **promise** is the very best in client service and guest experience.

Wilderness Safaris is an ecotourism company dedicated to responsible tourism throughout the areas in which it operates in Africa. Our goal is to share these wild areas with guests from all over the world, while at the same time helping to ensure the future protection of Africa's spectacular wildlife heritage and sharing the benefits of tourism with local communities.

We operate camps and safaris in some of Africa's most impressive and untouched wildlife areas in nine different countries: Botswana, Congo (Brazzaville), Kenya, Namibia, Malawi, South Africa, Zambia, Zimbabwe and the Seychelles.

Recognising that conservation is as much about people as about the environment, our operations and work ethics are guided by the 4Cs strategy – Commerce, Conservation, Community and Culture. Supported by Wilderness Safaris, our all-important Children in the Wilderness programme, as well as our Wilderness Wildlife Trust, helps drive this strategy.

Wilderness Safaris is part of the Wilderness Organisation, a group of responsible ecotourism companies and conservation and community development vehicles that together endeavour to build sustainable conservation economies in Africa.

Wilderness as a Tour Operator

In addition to our wide range of camps, the company also assists guests with their full itinerary. We have offices in each country, through which our Journey Specialists coordinate travel arrangements for our overseas agents and operators. This full-service travel operation handles accommodation requests for individuals, groups and incentives, including air tickets, air charters, transfers and touring, allowing us to be independent and book any itinerary to suit the taste and budget of all our guests.

Offices: Maun (Botswana), Lilongwe (Malawi), Windhoek (Namibia), Johannesburg (head office) and Cape Town (South Africa), Livingstone (Zambia; tours and transfers only), Victoria Falls (Zimbabwe)



WHY TRAVEL WITH WILDERNESS SAFARIS?

Today we have so much choice when it comes to travelling, it's often difficult to make a decision on the country in which to travel, let alone deciding whom to travel with. Wilderness Safaris makes the choice easy. Not only do we have camps and lodges in nine countries across Africa, but we are a long-running and industry leading company some 30 years of experience in the industry.

- Wilderness Safaris offers our guests exclusive access to more than 3 million hectares (8 million acres) of Africa's best wildlife areas. This equates to 3 000 hectares (8 000 acres) of private land per guest, creating a unique sense of seclusion, comfort, privacy and space.
- Our areas cover many habitats, encompassing parts of nine of Africa's eleven biomes, thus allowing for incredibly diverse and all-round experiences, whether in the savannah, the rainforest, the desert or the ocean.
- To satisfy individual needs and personalities, our properties range from high-end luxury to more affordable options.
- We work hand in hand with our agents to design a journey that suits their guests' budget and bucket list.
- We have our own air bush airline – Wilderness Air – creating a seamless journey that allows our guests to move from one place to the next on their itinerary without hassles.
- We offer complete, tailor-made services throughout southern Africa including logistics, sightseeing and accommodation in our camps as well as an extensive list of accommodation.
- We operate a touring and transfers business – Wilderness Touring – in the tourism hubs of Cape Town (South Africa), Victoria Falls (Zimbabwe) and Windhoek (Namibia).

At Wilderness Safaris, we create journeys, not holidays. A journey is an immersive experience, one that changes how you view the world in general and the wild places of Africa in particular.





DESIGNING YOUR SAFARI

Designing a safari is an important part of the African journey. Given the diversity and immense topography of the continent, it is impossible to see everything in one trip or even a lifetime of return visits.

Combining destinations is the best way to discover the diverse wildlife species that thrive in different habitats. Our camps and concessions offer a multiplicity of species, scenery and activities and are thus easily combined to create the perfect itinerary.

In Botswana, for example, it is worth combining the dryer areas of the Kalahari, the permanent swamps and waterways of the Okavango Delta and the mixed plains and woodlands of the Linyanti. In other areas, such as Namibia, South Africa and Malawi, the diversity of landscapes and ecosystems is even more significant and it is definitely worth visiting more than one or two camps.

The different regions in which we operate not only showcase the variety of wildlife within distinctive landscapes but explore the cultural diversity of each region. To broaden this outlook further, guests may even consider choosing to visit a number of countries.

Lastly, but equally as important, is deciding what time of year to travel. Seasons vary between destinations, however for those seeking to view the birthing season of many animals within an abundant setting, or for birding enthusiasts, summer is generally the best time to travel. For those seeking dryer landscapes and teeming herds around limited water resources, winter is the season.

When planning an itinerary within a country – or more than one – start by considering the areas and time of year first, and the camps second. In this way you'll ensure a diverse experience that allows your guests to absorb all the variety that Africa has to offer.





SUGGESTED ITINERARIES

The huge continent of Africa offers a bewildering array of choices for the traveller: so much to see and do, yet where to begin, what to combine and how long to spend to create that ultimate safari?

Our suggested itineraries are a starting point and showcase just some of the best that each country has to offer, combining a selection of its excellent features into one seamless safari.

These itineraries take in the most biodiverse areas, intentionally combining different landscapes and vegetation types to ensure travellers cram as much as possible into the most logistically feasible trips and experience different wildlife species, cultures, scenery and activities.

In the eight countries we have covered here we have chosen to split the prime attractions into two categories: Essential and Other Highlights.

ESSENTIAL: when time is of the essence, these combinations ensure a good, all round ‘must do.’

OTHER HIGHLIGHTS: in many cases these locations might be viewed as essential and all add enormous value, but usually require a bit more time to be added to the Essential itinerary.

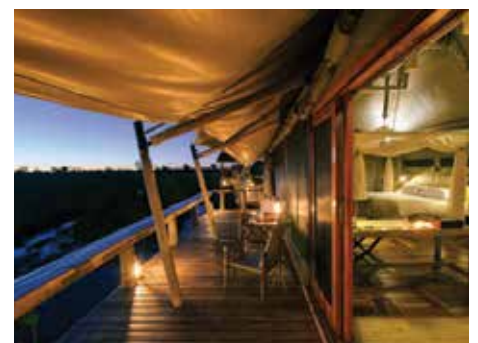

BOTSWANA

ESSENTIAL BOTSWANA: 8 – 11 NIGHTS

Okavango 'Land' Camps 3 – 4 nights



Predominantly game drives and occasionally walks (dependent on season and location) exploring the floodplains, and woodlands of the Okavango.

Choose: Mombo, Little Mombo, Vumbura Plains, Little Vumbura, Duba Plains, Kwetsani, Jao, Tubu Tree, Chitabe, Chitabe Lediba, Banoka, Seba.

Okavango 'Water' Camps 2 – 3 nights



Quintessential Okavango experiences – poling by mokoro or motor-boating along idyllic waterways. The Okavango Delta is an astounding natural wetland wonder.

Choose: Xigera, Vumbura Plains, Little Vumbura, Jacana, Seba.

The Linyanti Region 3 – 4 nights



Best combined with any Okavango Delta camp, boasting very different habitats, healthy predator numbers and seasonal wildlife concentrations.

Choose: Kings Pool, DumaTau, Savuti Camp.

Note: Vumbura Plains, Little Vumbura, Duba Plains, Banoka, Jao and Seba offer both land and water activities at certain times of year.

BOTSWANA – OTHER HIGHLIGHTS

The Central Kalahari 3 – 4 nights



The immense, arid Kalahari and its unique wildlife is a complete contrast to the Okavango Delta and Linyanti regions.

Choose: Kalahari Plains Camp.

Okavango – Abu Concession 3 – 7 nights



Africa's ultimate educational elephant safari – including vital conservation work that extends beyond Botswana's borders.

Choose: Abu Camp.

Victoria Falls 2 – 3 nights



Perfect grand finale to any Botswana itinerary. Choose between adrenalin-loaded activities, simple relaxation or wildlife viewing.

Choose: The River Club, Toka Leya (both on the Zambian side).

Wilderness Touring Victoria Falls can assist with various sightseeing options.

NAMIBIA

ESSENTIAL NAMIBIA – CENTRAL: 8 – 11 NIGHTS

Sossusvlei 2 – 3 nights



Experience the world's highest dunes in the ancient and spectacular red sands of the Namib Desert. Known as the "Sand Sea," the dunes are visible even from space.

Choose: Little Kulala, Kulala Desert Lodge.

Damaraland 3 – 4 nights



Expansive landscapes, unique desert-adapted wildlife and strong cultural element in award-winning community conservancies. Added paleoanthropology and geological wonders.

Choose: Damaraland Camp, Doro Nawas Camp.

Etosha 3 – 4 nights



Enormous Etosha Pan – including animal-filled plains, unique topography and network of easy wildlife-viewing waterholes.

Choose: Little Ongava, Ongava Lodge, Ongava Tented Camp, Andersson's Camp.

ESSENTIAL NAMIBIA – NORTH-WEST: 9 – 11 NIGHTS

Palmwag Concession – south 3 nights



An immense area (twice the size of Luxembourg) supporting a surprisingly high population of desert-adapted wildlife including the largest free-roaming population of black rhino on communal land, oryx, mountain zebra and lion.

Choose: Desert Rhino Camp.

Palmwag Concession – north 3 – 4 nights



Located in the most remote part of the Kaokoveld, a stark land of mountains, vast plains, dry riverbeds, desert oases and the Atlantic Coast – and inhabited by fascinating wildlife ranging from elephant and lion to giraffe and antelope.

Choose: Hoanib Skeleton Coast.

Kunene 3 – 4 nights



An area of phenomenal desert scenery, semi-nomadic traditional cultures and utmost exclusivity on the banks of the Kunene River in the most remote part of Namibia.

Choose: Serra Cafema.

ZIMBABWE & ZAMBIA

ESSENTIAL ZIMBABWE: 8 – 13 NIGHTS

Hwange National Park 3 – 5 nights



Zimbabwe's largest and best-known park, celebrated for its productive savannah woodlands, large elephant population and high plains game densities.

Choose: Little Makalolo Camp, Makalolo Plains Camp, Davison's Camp.

Mana Pools National Park 3 – 5 nights



This World Heritage Site centres on the productive floodplains of the Zambezi River, offering some of Zimbabwe's best game viewing and birding.

Choose: Ruckomechi Camp.

Victoria Falls (Livingstone) 2 – 3 nights



Perfect grand finale to any Zimbabwe itinerary. Choose between adrenalin-loaded activities, simple relaxation or wildlife viewing.

Choose: The River Club, Toka Leya (both on the Zambian side).

Wilderness Touring Victoria Falls can assist with various sightseeing options.

ESSENTIAL ZAMBIA: 8 – 12 NIGHTS

Kafue National Park 3 – 5 nights



Zambia's largest national park includes the Busanga Plains with its 'swamp lions', vast tracts of wilderness and high concentrations of unique mammals.

Choose: Shumba Camp, Busanga Bush Camp.

South Luangwa National Park 3 – 4 nights



The world-renowned Luangwa offers high-density and high-intensity game viewing during the dry season, either on foot or by vehicle.

Choose: Kalamu Lagoon Camp.

Victoria Falls (Livingstone) 2 – 3 nights



One of the World's Seven Natural Wonders straddles Zambia and Zimbabwe.

Livingstone is the adrenalin capital where one can take part in many adventure activities or just relax and reflect after a safari.

Choose: The River Club, Toka Leya Camp.

MALAWI

ESSENTIAL MALAWI – SOUTH: 5 – 8 NIGHTS

Liwonde National Park 3 – 4 nights



Malawi's primary wildlife gem, set along one of Africa's mighty rivers – the Shire. High densities of elephant, hippo and sable populations, as well as other game including black rhino, are encountered on game drives, boating activities and walks.

Choose: Mvuu Lodge, Mvuu Camp.



Lake Malawi National Park 2 – 4 nights



Africa's first fresh water national park; proclaimed to protect the amazing diversity of fish species. It is hard to beat the idyllic island scenery of one of Africa's Great Lakes. Relaxed? Lie on your own beach. Energised? Kayak to the next island...

Choose: Mumbo Island Camp.

ESSENTIAL MALAWI – NORTH: 6 – 8 NIGHTS

Nyika National Park 3 – 4 nights



Malawi's largest park and the only Afro-montane big game area in Africa; these scenic high altitude grasslands and forest patches host good populations of leopard, spotted hyaena, roan, zebra and eland, as well as a huge number of orchids and bird species. Truly unique.

Choose: Chelinda Lodge, Chelinda Camp.



Central Lakeshore 3 – 4 nights



Enjoy down-to-earth hospitality and relax on one of Lake Malawi's finest beaches. Away from the Inn engage with some of the friendliest people in Africa and embrace local culture in village visits and homemade cuisine.

Choose: Chintcheche Inn.

SOUTH AFRICA & KENYA

ESSENTIAL SOUTH AFRICA: 5 – 10 NIGHTS

ESSENTIAL SOUTH AFRICA: 5 – 10 NIGHTS

Kruger National Park: Makuleke Concession 3 – 4 nights



This northernmost corner of Africa's best known national park delivers an unrivalled Kruger experience – big game, stunning scenery and specialist species all in one.

Choose: Pafuri Camp.

Cape Town 2 – 6 nights



Use **Wilderness Safaris Partner Product** and **Wilderness Touring Cape** to add adventures in Cape Town, the winelands, the Garden Route and further afield.

iSimangaliso Wetland Park: Rocktail Bay 3 – 4 nights



40 km of private, unspoilt and secluded turtle-nesting beaches; unique coastal dune forest; world-class diving and snorkelling. Ideal for families.

Choose: Rocktail Beach Camp.

ESSENTIAL KENYA: 9 – 13 NIGHTS

Laikipia Plateau 3 – 6 nights



The scenic central highlands of Laikipia, with Mt. Kenya as a backdrop, offer abundant wildlife including a number of northern endemics like reticulated giraffe and Grevy's zebra. Nearby Samburu is a great addition.

Choose: Segera Retreat.

Masai Mara National Reserve 3 – 4 nights



Known for its abundant predators, the immense wildebeest migration spectacle and the Maasai people. A must-do on any Kenya safari.

Choose: Saruni, Elephant Pepper, Cottars 1920S.

Amboseli National Park 3 nights



Nestled on productive volcanic plains below iconic, snow-capped Kilimanjaro, Amboseli is well known for its elephants and other high-profile game species.

Choose: Tortillis Camp.

REPUBLIC OF THE CONGO

ESSENTIAL CONGO – ODZALA-KOKOUA NATIONAL PARK: 6 – 8 NIGHTS

Odzala – Lango Camp 3 nights



Odzala is Congo's oldest and largest national park covering 13 600km² of pristine rainforest and a limited area of savannah. Lango Bai is a magnet for many forest mammal and bird species such as forest elephant, forest buffalo, sitatunga, bongo and many primates.

Choose: Lango Camp.

Odzala – Ngaga Camp 3 nights



Just beyond the border of Odzala lies the Ndzehi Forest, an area of primary rainforest with high densities of both western lowland gorillas and chimpanzees. Habituated gorilla groups can be tracked on foot and observed in their natural environment.

Choose: Ngaga Camp

Brazzaville 1 – 2 nights



Depending on connecting flights in and out of the country, many guests spend one or two nights in the capital city, Brazzaville, on the banks of the mighty Congo River.

Choose: Mikhael's Hotel

CONGO – OTHER HIGHLIGHTS

Nouable-Ndoki National Park 3 – 4 nights



Protected by the Congolese Government and the Wildlife Conservation Society for the past 20 years, Nouabale-Ndoki offers excellent habitats for lowland gorilla viewing as well as the productive Mbeli Bai.

Choose: Mbeli Bai Camp.

Dzanga-Sangha National Park 3 – 4 nights



An extraordinary park, in neighbouring Central African Republic, home to a wide array of forest wildlife and traditional B'Aka cultures and Dzanga Bai, perhaps Africa's best bai for forest elephant and bongo viewing.

Choose: Sangha Lodge.

São Tome and Príncipe 3 – 7 nights



Tropical Atlantic Ocean islands lying off the Gabonese coast. Golden beaches, turtles, whales and endemic wildlife give the perfect end to a west-central African safari.

Choose: Bom Bom Island Resort, Omali Lodge.



CHOOSING YOUR CAMPS

In order to host our guests, and therefore ensure the sustainable protection of the wilderness areas in which we operate, we have built a selection of small intimate safari camps across southern Africa. Of paramount importance to us is that our camps cause as little impact on the environment as possible. This is relevant not only during the building process, but also during day-to-day operating and takes into account all elements of environmental impact, from the visual and aural implications, to effects on soil, the water table, vegetation, game movement, and so on.



WILDERNESS SAFARIS PREMIER

This is the highest level of camps in our portfolio and comprises our most elegant and stylised accommodation. These camps combine luxury, superbly designed architecture with the warm comforts of home and personal service. Each Premier Camp has its own individual style, as well as additional features such as salas for a soothing midday siesta. Each tent or bedroom has an en-suite bathroom, often with an outdoor shower 'under the stars.'



WILDERNESS SAFARIS CLASSIC

Our Classic camps are generally tented camps, although a few are lodges built from permanent structures. All these camps offer superb facilities and accommodation, the bedrooms being slightly smaller than those of our Premier camps. Many of the Classic Wilderness tents are raised off the ground with interconnecting walkways. All tents have en-suite bathrooms.



WILDERNESS SAFARIS ADVENTURES

Adventures Camps are comprised mainly of thatch and canvas although a few are constructed of more permanent materials. The rooms are smaller and more rustic than Wilderness Safaris Classic Camps but extremely comfortable and form part of a larger camp than the Premier or Classic camps. Note: activities at these camps may be at extra cost.



WILDERNESS SAFARIS EXPLORATIONS

There are a number of different accommodation styles used on Explorations itineraries, including our own unique Discoverer, Adventurer and Trails camps. The tents of these camps are spacious with an original design and all comforts and amenities provided. (See the Exploration section of this brochure for details.)





Wilderness Collection

The Wilderness Collection is a portfolio of exceptional properties dotted across Africa and its nearby islands. Not necessarily 'safari camps', properties in the Collection share a commitment to global sustainability and use responsible tourism experiences to highlight the earth's plight and how discerning travellers can make a difference, whether this be island rehabilitation, community unity or vast conservation areas. Each location is dedicated to unashamed luxury and exceptional guest experiences.



ACTIVITIES AND FACILITIES ON SAFARI & IN CAMP

A variety of activities can be enjoyed on safari. For each of the safaris or camps described in this brochure, the symbols for the predominant activities are shown on their respective pages. Listed below are the activity and facility symbols.

Guest Rooms	Tented Camp	Family Room	Discoverer Exploration	Adventurer Exploration	Trails Exploration	Pool	Private plunge pool at each room	Hides
Game Drive (Day)	Game Drive (Night)	Explorations Vehicle (Day)	Explorations Vehicle (Night)	Guided Walks	Guided Walks Seasonal	Cultural Experiences		
Canoeing /Kayaking	Flat-Bottom Boat	Mokoros	Mokoros Seasonal	Boating	Boating Seasonal	Birding		
Fishing	Fishing Seasonal	Rhino Tracking on foot	Horse Riding	Seal Colony	Elephant Activities	Gorilla Tracking		
Floodlit Waterhole	Hot Air Ballooning	Quad Biking	Bike Rides	Scuba Diving/ Snorkelling	Massage Treatments	Spa Treatments	Gym	

- AN INTRODUCTION TO -
BOTSWANA



Situated in the centre of southern Africa, landlocked Botswana has Namibia, South Africa, Zambia and Zimbabwe as its neighbours. With the exception of the eastern part where the summer rainfall is slightly higher, the Kalahari Desert forms the majority of Botswana. This predominance of arid land makes for a remarkable phenomenon: The Okavango Delta is a wondrous wetland within a desert, receiving its waters from rain falling over a thousand kilometres away, and sustaining a huge diversity of fauna and flora. In the north-east of the country, the Chobe and Linyanti reserves are renowned for their predators and large concentrations of game.

Historically Botswana is one of Africa's outstanding success stories. Prior to independence in 1966, it was one of the world's poorest countries, an unexplored land only visited by hardy adventurers. Botswana embarked on innovative and proactive ways to deal with tourism, the second largest export sector after diamonds. The country's leaders took the view that high quality, low volume tourism was the best way to create a sustainable industry that would employ a large percentage of its people while still preserving the environment.



OUR BOTSWANA AREAS

The Okavango Delta

The Okavango Delta is rightly considered one of the most incredible wilderness sanctuaries in Africa. It is one of the largest inland delta systems in the world, an area of 15 000km² filled with water channels, lagoons and islands. What makes this area truly remarkable is that it is a wetland paradise located deep within the arid Kalahari Desert. Each year, floodwaters flow from their catchment areas in the moist central African highlands over 1 000km away into the Delta to create the miracle that is the Okavango. This unique area sustains a huge diversity of fauna and flora, so that game viewing is excellent right through the year.



Xigera Concession

The 6 000-hectare Xigera Concession is a wetland paradise within Moremi Game Reserve in the heart of the Delta. Situated on one of the Okavango's key waterways, it is surrounded by picturesque papyrus swamps and wooded islands and is renowned for the highest density of the elusive sitatunga antelope in the Delta. Although the area is not known for big game, mammal sightings include red lechwe, spotted-necked otter, elephant and tsessebe. Predators include lion, spotted hyaena and leopard. Guests are sometimes treated to close-up views of lion or leopard using the footbridge connecting Xigera's island to the next! This concession is a delight for birdwatchers, many of the key swamp-dwelling specialists being resident. Notable are Pel's Fishing-Owl, African Skimmer, Brown Firefinch, Greater Swamp Warbler, Wattled Crane, African Pygmy Goose and Lesser Jacana.



Abu Concession

In the south-west of the Delta, the scenically splendid 173 000-hectare Abu Concession varies from seasonally inundated floodplains, channels and palm islands in the north-east to the dryer Kalahari 'Sandveld Tongue' in the west. Here trees like Kalahari appleleaf and silver terminalia dominate, adding much contrast to this unique area. Big game is plentiful and includes frequent sightings of giraffe, buffalo, elephant, red lechwe, blue wildebeest, tsessebe, impala, zebra, hippo and warthog. Dominant carnivores include lion and spotted hyaena with occasional leopard and wild dog. For bird enthusiasts, some 380 different species can be found.



Khwai Concession

The 180 000-hectare Khwai Community Concession lies in the north-eastern corner of the Okavango Delta adjoining the Moremi Game Reserve with a wide range of habitats: a blend of riparian forest, floodplain, wetland and grasslands. The narrow Khwai Channel is home to hippo, crocodile and buffalo with red lechwe often grazing along the fringe. The beautiful gallery riverine woodland, dominated by ancient camelthorn, knobthorn and appleleaf, provides sanctuary to birds, primates and leopard. Elusive roan and sable antelope often drink at the river. The floodplains offer common species including kudu, tsessebe, zebra and wildebeest while the mopane woodland together with the permanent presence of water attracts large numbers of elephant to the area. Larger predators include lion, wild dog and spotted hyaena. Birds seen include Verreaux's Eagle-owl, Senegal Coucal, Long-toed Lapwing and Arnot's Chat.



Mombo Concession

The Mombo Concession comprises 45 000 hectares of the Moremi Game Reserve and is located on Chief's Island in the central Okavango Delta. In the interior of Chief's Island, mopane woodland is interspersed with belts of Kalahari sand and acacia. Towards the edges of the island regular seasonal flooding creates shallow floodplains dotted with wild date palm islands and riverine forest. Mombo offers arguably the best big game viewing in Botswana with prolific concentrations of general game such as giraffe, zebra, warthog, red lechwe, tsessebe, wildebeest, kudu, elephant, buffalo and impala. Abundant predator sightings include lion, spotted hyaena and leopard. Chief's Island is also home to the only white and black rhino found in the Okavango Delta. The birding, a result of diverse habitats, is equally attractive.



Kwedi Concession

The 90 000-hectare Kwedi Concession in the northern Okavango Delta comprises Duba Plains and Vumbura areas. While its western parts, notably the large Duba Island, have seasonally inundated floodplains and small palm islands, the eastern region consists of diverse habitat types: permanent swamp, seasonal floodplains, acacia woodlands, and mopane / Kalahari appleleaf stands. The concession is leased from five communities through the Okavango Community Trust in a groundbreaking partnership, ensuring that the benefits of ecotourism are shared with rural stakeholders. Duba is known for regular interaction between large buffalo herds and resident lion prides, as well as fantastic viewing of unusual small carnivores such as aardwolf, bat-eared fox and side-striped jackal. Vumbura features a wider range of large mammals including a broad complement of antelope, good populations of elephant, buffalo, hippo and giraffe, and large predators: lion, spotted hyaena, leopard, wild dog and cheetah. Bird life is abundant with Okavango specials such as Rosy-throated Longclaw, Black Coucal and Wattled Crane found. The woodlands in the east harbour White-breasted Cuckooshrike and Racket-tailed Roller.



Jao Concession

Close to the Panhandle in the Delta's north-west, the 60 000-hectare Jao Concession's vegetation varies from east to west: from the magical Jao Flats – picturesque floodplains with lush palm islands and riparian forest – to the dryer Hunda Island, covered in acacia and mopane woodland and the largest area of dry land locally during the annual floods. Around the Jao Flats spectacular herds of red lechwe are followed by the primary predators – lion and leopard. Other game includes wildebeest, tsessebe, giraffe, elephant, hippo and crocodile. Sitatunga are seen occasionally, and sightings of spotted-necked otter are regular. The drier habitats in the west harbour similar species with greater concentrations of zebra and wildebeest. Birding is exceptional with large concentrations of endangered Wattled Crane, Slaty Egret, Rosy-throated Longclaw, Pel's Fishing-Owl, and Lesser Jacana on the eastern side; the western drier areas are ideal for Crimson-breasted Shrike, Dickinson's Kestrel and Meyer's Parrots.



Chitabe Concession

The 28 000-hectare Chitabe Concession, situated in the south-east of the Okavango Delta, is separated from the well-known Moremi Game Reserve by the Gomoti Channel. This eastern half of the concession is characterised by grassy floodplains which separate the Channel from acacia and mopane woodland. The western half of the concession has as its boundary the Santantadibe River and here a variety of typical Okavango habitats – seasonal palm-dotted floodplains, to wooded islands, tranquil waterways and dry woodland – ensure a year-round variety of game viewing and birding experiences. It is this diversity and a mix of Okavango and Kalahari habitats that makes Chitabe unique and which allows good concentrations of all the larger predators – lion, leopard, spotted hyaena, cheetah and wild dog – as well as herbivores like giraffe, buffalo, lechwe, tsessebe, impala and elephant.



The Linyanti

To the north-east of the Okavango Delta, along the Linyanti Fault line, lie the Chobe, Selinda and Linyanti areas. The varied woodland habitats and ancient floodplains make adding any of the camps found here to a Botswana itinerary a good choice for a balanced experience of the country. In many ways the Linyanti is an essential complement to an Okavango visit. The area is home to several unique features: the Savute Channel, once again a river in its own right attracting abundant wildlife; the Selinda Spillway, a mythic connection to the Okavango; and the productive Linyanti River frontage. Seasonal zebra and elephant migrations add further drama and the Linyanti expanse is the favoured hunting ground for healthy numbers of predators.



Linyanti Concession

The 125 000-hectare Linyanti Concession bordering Chobe National Park's western boundary is an enormous wildlife-rich area with an unrivalled atmosphere of remoteness and space. The bulk of the concession is comprised of different mopane woodland associations, but along the Linyanti River exists a strip of riparian forest and floodplain. The concession is bisected by an ancient watercourse – the now-flowing Savute Channel – which provides a year-round water source to complement the Linyanti. The area is famed for its herds of elephant that reach the world's highest densities in the dry winter months. Other species are also abundant – zebra, wildebeest, impala, giraffe, lechwe, reedbuck, kudu – and in addition to species like lion, spotted hyaena and leopard, the area also plays host to healthy populations of cheetah and wild dog. Rarer species such as sable and roan emerge from the woodlands during the dry season.



Selinda Concession

Lying adjacent to the Linyanti, the 135 000-hectare Selinda Concession is ecologically similar, but differs in the increased extent of its floodplains. Like the Linyanti, in the dry winter months, enormous elephant herds dominate the large mammal landscape and concentrate close to the permanent Zibadianja Lagoon (the 'source' of the Savute Channel). In addition, plains game such as lechwe, wildebeest, zebra and giraffe, together with their rarer counterparts such as roan, are found, followed by predators – lion, cheetah, leopard, hyaena and wild dog. Birding too is unique here including Arnot's Chat, Collared Palm-Thrush and brilliant flocks of Carmine Bee-eaters hitching rides on Kori Bustards.



The Central Kalahari

South of the Okavango Delta and dominating central Botswana, the 5 million-hectare Central Kalahari Game Reserve is one of the biggest protected areas in Africa, its diverse wildlife and wonderful scenery offering an amazing contrast to the rest of the country. The Kalahari Desert is the largest unbroken stretch of sand in the world and at its core is the Central Kalahari Game Reserve, a vast flat expanse of scrub-covered fossil dunes interspersed with ancient river valleys. This area is home to a fascinating spectrum of very different plants and animals that have successfully adapted to living in such a harsh environment.



Central Kalahari Game Reserve

In the northern plains of the Central Kalahari Game Reserve, sweeping vistas and acacia savannah mosaics direct the landscape and hold significant populations of large predators such as lion, cheetah and brown hyaena. Herbivore aggregations include impressive herds of springbok, wildebeest and gemsbok as well as bat-eared fox, meerkats and ground squirrels. The plains game populations move seasonally between dune and valley: in summer the verdant flatlands are a thriving wildlife mosaic whilst in winter a series of ecologically-placed waterholes enhance game viewing. Over 220 bird species include significant populations of regionally threatened and arid-west endemic species including memorable species like Crimson-breasted Shrike, Violet-eared Waxbill and Southern Pied Babbler.





MOMBO CAMP

Wilderness Safaris - Premier Camp



Mombo Camp, on Momo Island just off the northern tip of Chief's Island, is built under large shady trees and overlooks a wonderful floodplain teeming with wildlife. Accommodation comprises nine spacious tents raised off the ground, all built to maximise the vistas over the plains. The tent interiors are elegantly furnished with polished parquet floors, complete with an outdoor thatched sala – an ideal vantage from which to watch passing game. Bathrooms are en-suite, with indoor and outdoor showers.



The main living and dining area is under thatch and there is a boma for traditional dinners, small library and a plunge pool to relax in the heat of the day. Large concentrations of plains game often occur in front of camp and guests may view a variety of animals without even leaving the veranda. Informative game drives explore the savannah and floodplain mosaics of Chief's Island with prolific wildlife viewing opportunities.



FACILITIES & ACTIVITIES





LITTLE MOMBO CAMP

Wilderness Safaris - Premier Camp



Little Mombo is an extension of and shares the same island as the larger Mombo Camp, matching its high standards. It offers the same abundant big game viewing – some of the best in Botswana – and overlooks a floodplain that is a beautiful setting for a variety of wildlife. The camp, built under a shady canopy, has luxurious and spacious guest rooms under canvas, each with en-suite facilities, outdoor shower and individual sala.

Little Mombo has only three rooms, but larger groups can also book out some of the rooms in the main camp. Little Mombo also has its own dining room, kitchen, lounge and plunge pool. Activities include morning and afternoon game drives in open 4x4 vehicles to view the high concentrations of plains game and their predators, which include all the big cats.



FACILITIES & ACTIVITIES

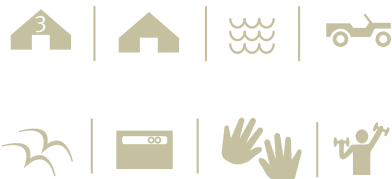



VUMBURA PLAINS

Wilderness Safaris - Premier Camp



Vumbura Plains is a luxury camp situated in the northern Okavango Delta, comprising two separate seven-roomed satellite camps, each with its own raised dining, lounge and bar area tucked beneath a canopy of shady, indigenous trees and with a vista across the floodplains. The main area lays emphasis on relaxation furnished with soft sofas and idiosyncratic objets d'art.



The rooms, raised off the ground, are unique in contemporary design; the dimensions are square, with extensive use of light wood and space. Each suite has a large, comfortable bedroom, sunken lounge with cushions, "sala", en-suite facilities, an outdoor shower, private deck and plunge pool. A family suite is also on offer with a private deck linking the two separate rooms. Vumbura Plains offers both land and water activities, principally game viewing in varied habitats on walks (on request), mekoro and boats, providing an excellent all-round experience.



FACILITIES & ACTIVITIES





LITTLE VUMBURA CAMP

Wilderness Safaris - Classic Camp



Little Vumbura is situated on a wooded island in the same region as its sister camp, Vumbura Plains. Designed to blend in with its surroundings, Little Vumbura is a beautiful six-roomed tented camp shaded by the canopy of an ancient Okavango forest. Each tent is en-suite, large and roomy with an open-air shower and views of the surroundings. A plunge pool and reading area overlook the floodplains and a star deck leads off the dining area.

Surrounded as it is by water and lying close to large rivers, water-based activities are a focus with mekoro traversing the floodplains under the guidance of experienced polers, and motor boats the permanent channels. Wildlife viewing and birding is consistently good all year round. Game drives in open Land Rovers explore the savanna areas. Walks (on request) around the islands are an opportunity to enjoy Africa from a different perspective.



FACILITIES & ACTIVITIES





DUBA PLAINS

Wilderness Safaris - Classic Camp



One of the Delta's most remote camps, Duba Plains is a small, intimate camp on an island surrounded by expansive seasonally flooded plains and shaded by tall ebony, fig and mangosteen trees. Due to its proximity to the Panhandle, Duba Plains is one of the first camps in the northern Delta to receive the annual floodwaters.



Accommodation is made up of six tents complete with en-suite bathroom, outside shower, and a small veranda overlooking the floodplain. Pathways link the tents to the main area, comprising dining room, swimming pool and fireplace, all raised to take in the view. Activities include day and night game drives to view wildlife such as lion, buffalo, elephant, hippo in the channels and red lechwe on the floodplains; birdlife is abundant. Duba was the setting for *Relentless Enemies*, a National Geographic documentary of the classic lion and buffalo interaction unique to the area.



FACILITIES & ACTIVITIES





JAO CAMP

Wilderness Safaris - Premier Camp



Jao Camp is located on a remote island in the heart of the Okavango Delta. The camp has nine luxurious tents, each individually handcrafted. The open-plan design of each includes a lounge, dressing area and main bedroom, en-suite facilities with old-style fittings and an outdoor shower. A private sala for afternoon siestas has magnificent views of the nearby channel. The main area is an elaborate two-storey building with lounge and dining area, two plunge pools, a small library, curio shop and a boma for dining under the stars, complemented by an excellent wine cellar. Jao's spa offers a wide range of massage therapies, and a gym.



With habitats that vary from waterways and lagoons to dry Kalahari grasslands, Jao offers both land and water experiences, depending on annual flood levels. Mokoro, boating, seasonal fishing, and day and night game drives are usually on offer all year round in one of the most picturesque concessions in the Delta.



FACILITIES & ACTIVITIES





JACANA CAMP

Wilderness Safaris - Classic Camp



Situated on a small island in the beautiful Jao Flats area of the concession, Jacana offers remote seclusion. Accommodation is in five spacious en-suite tents – each with an outdoor shower – built on raised wooden decks, all with stunning views over the water.

The main dining area is on an elevated wooden deck between two enormous sycamore trees, and surrounded by dense wild date palms. Downstairs, there is a cosy lounge with large viewing deck, and open area to sit around the fire. Behind this is another thatched relaxation area with hammocks. Meals are sometimes enjoyed outdoors in a traditional African boma.



Jacana Camp is a true water camp, offering mokoro safaris as well as day game drives all year round.



FACILITIES & ACTIVITIES





KWETSANI CAMP

Wilderness Safaris - Classic Camp



Kwetsani, one of the most remote camps in the Okavango, is situated on an elongated island covered with palm, mangosteen and fig trees. Five beautifully furnished ‘tree-house’ chalets, each with its own ensuite bathroom and outdoor shower provide guests with open, airy accommodation of thatch, wood, glass and canvas. All are elevated and connected with wooden walkways.

The main area includes a dining room and lounge area situated under a cool thatched roof, and leads onto an expansive wooden deck that looks out over an enormous floodplain often dotted with plains game. A walkway leads to a plunge pool with loungers – a perfect spot to relax at midday. Guests can watch the animals from the comfort of the pool or the privacy of their rooms.

Kwetsani offers excellent land and water activities dependent on annual flood levels. Guests can view wildlife by mokoro or experience outstanding game drives. During times of high water levels, Kwetsani boats to Hunda Island for game drives.



FACILITIES & ACTIVITIES





TUBU TREE CAMP

Wilderness Safaris - Classic Camp



Tubu Tree lies on the western side of the isolated Hunda Island. Elevated walkways through the canopy link the traditional style camp with five (eight as of July 2013) secluded tents on raised platforms, taking in the marvellous scenery of the surrounding floodplain. Each tent has a private front deck, en-suite bathroom facilities and an outdoor shower. A family unit consisting of two adjoining tents with separate bathrooms and a shared lounge will be available from July 2013.



The main dining and lounge areas are raised on platforms with an outdoor bar under the spreading boughs of a marula tree. The pool deck below affords uninterrupted views over the ever-changing plain.

Owing to its locale and easy access to diverse habitats, Tubu Tree ensures excellent game viewing. Activities include day and night game drives in open 4x4 vehicles with access to productive mopane and acacia woodlands. During the winter season (normally May to late September), boating, seasonal fishing and mokoro trips are also offered.

FACILITIES & ACTIVITIES





LITTLE TUBU

Wilderness Safaris - Classic Camp



Little Tubu (opening June 2013) is situated on Hunda Island, in close proximity to its sister camp, Tubu Tree. Hunda Island, which is the largest dry land environment in this area, hosts a mix of diverse habitats, which ensures a varied and spectacular game viewing experience.

Little Tubu has three traditional-style tents, all with en-suite bathroom facilities, and private decks to maximise the view. The elevated dining, bar and pool decks are shaded by a riverine tree canopy and look out over a seasonal riverbed, which ebbs and flows with the passage of a variety of game.

Activities include day and night game drives in open 4x4 vehicles with access to productive mopane and acacia woodlands. During the winter season (normally May to late September), boating, seasonal fishing and mokoro trips are also offered.



FACILITIES & ACTIVITIES





ABU CAMP

Wilderness Collection



Abu Camp provides guests with the extraordinary privilege of interacting with African elephants, of being part of an elephant herd, meeting each individual and beginning to understand what makes the largest land mammal tick. This is possibly the ultimate elephant educational safari.



Set in age-old riverine forest, Abu Camp consists of six en-suite tents designed in a unique “Afro-Bedouin” style: wide, airy and blending in well with the natural surroundings. Each tent has its own tree-shaded deck overlooking the lagoon, which thrives with bird and animal life. The lounge and dining tent has a breathtaking view over the lagoon and features a well-stocked library and a study. There is also a gym for those feeling energetic. Sundowners around a traditional campfire are followed by five-star meals complemented by award-winning wines. End your evening curling up above the elephants in a one-of-a-kind “star-bed” whilst listening to the herd’s low snores below.

The elephant encounters include riding and walking with the herd through the bush. Abu also offers game drives, night drives, walks (on request) and mokoro trips to view the abundance of game in the area.



FACILITIES & ACTIVITIES





SEBA CAMP

Wilderness Safaris - Classic Camp



Seba Camp, set in an ancient riverine forest, offers secluded accommodation overlooking a perennial lagoon. It has eight well-appointed and spacious elevated tents, each with en-suite bathroom and private deck. Seba is family-friendly, complete with family villa with two interleading en-suite bedrooms, a built-in 'tree-house' and a kids' swimming pool and sandpit. The dining area is set on a raised saligna deck with spectacular views.

The camp is named after Seba, one of the elephants historically released from nearby Abu Camp. A number of elephants that were released back into the wild have formed their own herd. The interaction between these and the wild herds in the area provides rich fodder for the researchers from the NGO Elephants Without Borders in the Abu Concession. Activities include day and night game drives, seasonal fishing and mokoro excursions on the waterways.



FACILITIES & ACTIVITIES





XIGERA CAMP

Wilderness Safaris - Classic Camp



Xigera Camp is situated deep within the Delta surrounded by water and lush vegetation. Nestled in riverine forest on the aptly-named Paradise Island, Xigera has ten luxuriously furnished tents (including a family room), a clever mix of wood and canvas, each with en-suite facilities and an outdoor shower. All are built on wooden decks, offering views of a seasonal floodplain and small lagoon. Meals and evening drinks are enjoyed in the lounge and dining area overlooking the permanently flowing channel or under the stars in a traditional African boma. The camp is rounded off with a plunge pool and curio shop.



The concession's year-round water allows for the Delta's most sublime experiences – poling on a mokoro and motorboat outings. This is complemented by game drives in the area depending on flood levels. Xigera also offers some of the best birding opportunities in the Delta.



FACILITIES & ACTIVITIES





CHITABE CAMP

Wilderness Safaris - Classic Camp



Chitabe is situated on a beautiful old tree-island in a prime location in the south-east of the Okavango Delta. Eight spacious en-suite Meru-style tented rooms are built on elevated wooden decks, each tastefully styled with unique décor. The spacious en-suite bathrooms include double vanity basins together with an indoor as well outdoor shower. Elevated walkways connect the rooms to the main area.

The central part of camp is made up of a thatched dining area and lounge leading onto open decking, all built on raised decks to provide superb views across a floodplain. There is a pool that provides cool sanctuary in the heat of the day.

Activities include day and night game drives in open 4x4 vehicles, nature walks (on request) and spectacular birding through a diverse array of habitats. Owing its location on the periphery of the Delta, Chitabe offers exciting year-round game viewing.



FACILITIES & ACTIVITIES





CHITABE LEDIBA

Wilderness Safaris - Classic Camp



Chitabe Lediba is located on the other side of the same island as its sister, Chitabe Camp. A smaller camp, accommodation consists of five canvas tented-style rooms, built on raised decks with luxurious interiors and in tasteful style, complete with en-suite bathrooms, including double vanity basins, indoor and outdoor shower with spectacular views. There are two family rooms, one (for older children) with an adjoining front deck and the other (for youngsters) with an adjoining corridor; each room however has its own en-suite facilities.



A dining area, lounge and pool have glorious views over the surrounding floodplains and the small *lediba* (remnant lagoon waterhole), where a variety of game comes to drink during the day.

Wildlife viewing is the major activity at this camp, whether on walks (on request), or day and night game drives in open 4x4 Land Rovers accompanied by an experienced guide.



FACILITIES & ACTIVITIES





BANOKA BUSH CAMP

Wilderness Safaris - Adventures Camp



Banoka Bush Camp is named in honour of the River San, or Banoka, ancestors of the Khoi and the earliest settlers of the Okavango Delta. It is situated in the Khwai Development Trust Community Concession, on the banks of the Khwai River; this incredibly diverse area hosts a wealth of wildlife.

Built along the tree-line overlooking a lagoon, the whole camp is raised off the ground to take in the view. Accommodation is in ten en-suite tented rooms each with a private veranda. The main area consists of a lounge, dining area and plunge pool and deck. The camp is 100% solar powered.

Activities include guided game drives, walks (on request) and traditional mokoro rides that allow one to float down the Khwai's secretive channels, creating that classic Delta experience. Fishing with a limited supply of basic equipment is on offer seasonally on a catch-and-release basis.



FACILITIES & ACTIVITIES





KINGS POOL

Wilderness Safaris - Premier Camp



Named for Scandinavian royalty, this luxurious and stylish camp overlooks the oxbow-shaped Kings Pool Lagoon and Linyanti River system.

Nine well-appointed rooms of canvas and thatch each have a large en-suite bedroom and lounge. Folding doors lead to a veranda with private plunge pool, separate thatched sala to soak up the views and an outdoor shower. The lounge and dining areas are set on expansive decks, and there is a pool and an open-air 'kgotla' (boma) for evening dining under the stars.



Activities include day and night game drives, walks (on request), and elegant boat cruises along the Linyanti River (water levels allowing) on Kings Pool's colonial-style barge, the Queen Sylvia. Two hides allow guests to spend their siesta watching game come down to drink. One is edge of the camp, while the other is underground, with the water at eye-level – seeing elephant feet and trunks almost within touching distance while safely inside is an experience that transcends that of an ordinary safari.



FACILITIES & ACTIVITIES





DUMATAU CAMP

Wilderness Safaris - Classic Camp



DumaTau Camp was rebuilt in 2012 on an exquisite new site on the banks of the Linyanti River's Osprey Lagoon. It is located close to the source of the Savute Channel in the western part of the Linyanti, between two elephant corridors, thus offering an exclusive combination of land and river experience.

The Classic Camp's ten en-suite tented units (8 twin and two family) are raised off the ground to overlook the Lagoon. The architecture evokes the age of the explorers along with a sense of space, thanks to the wraparound clear-storey window providing dramatic views of the river. The main areas include an expansive deck and dining and lounge areas all sporting the same vista.

Activities allow guests to view game during day and night game drives, on short nature walks (on request), and while boating along the serene waters of the Linyanti River (levels permitting).

DumaTau Camp operates completely on solar energy, for hot water, lighting and other energy needs, and is built of FSC-standard timber.



FACILITIES & ACTIVITIES





SAVUTI CAMP

Wilderness Safaris - Classic Camp



Savuti Camp is located on the Savute Channel, which for many years was dry, wide-open ribbon of grassland snaking through the adjoining woodland. In 2008, the waters returned, and Savuti Camp now has front-row seats to view the abundant game that has congregated and adapted in its wake. The site of the camp is about 17 kilometres 'downstream' from the Zibadianja Lagoon – the source of the Channel.



Accommodation comprises seven large en-suite canvas-and-thatch rooms that are raised off the ground and face onto the Savute Channel. From the thatched dining area, a plunge pool and large viewing area with fire pit extend outwards on raised wooden decks towards the new waters that flow past the camp. Activities on offer are day and night game drives and nature walks with a guide (on request).



FACILITIES & ACTIVITIES





ZARAF A CAMP

Wilderness Safaris - Premier Camp



Zarafa Camp is where extreme green blends seamlessly with flowing canvas and opulent luxury. Each of Zarafa's four large, sumptuous tents and its generous veranda is positioned under cool and shady trees with spectacular views onto the Zibadianja Lagoon. The spacious bedroom has a lounge, en-suite bathroom with copper bath, indoor as well as outdoor shower, copper heater for cosy winters as well as its own private pool for summer. The main area is furnished in the same style as the tents and evokes the traditional safari ambiance of the turn of the last century.

Lounge and dining facilities may be enjoyed under canvas or on the full-length deck shaded by giant broad-leafed trees, enjoying the expansive view and the wildlife that passes by. Activities are flexible to suit guests' interests and include day and night game drives in custom-built 4x4 vehicles. Guided nature walks from camp are also offered. All of the Chobe wildlife is present at Zarafa with an interesting and varied bird life.



FACILITIES & ACTIVITIES





SELINDA CAMP

Wilderness Safaris - Classic Camp



Selinda Camp overlooks the Selinda Spillway, a unique waterway that links the Okavango Delta with the wildlife-rich floodplains of the Linyanti Marshes. Selinda Camp's nine spacious tents (including a family unit) are tucked away into the natural vegetation with wonderful views of palm-studded floodplains. Each tented room has an en-suite bathroom and veranda. The main area is attractive, cool, under thatch and comprises dining, lounge and bar areas with spectacular views. The open air deck has served many memorable dinners over the years under the stars. Set apart from the main area is the photo and art gallery built next to the camp's wine cellar. Guests enjoy the cooling plunge pool and the traditional campfire.



Daily activities revolve around guided morning, afternoon and night game drives in custom-built 4x4 Land Cruisers, boating and seasonal fly-fishing. Nature walks accompanied by an armed guide are a Selinda speciality.



FACILITIES & ACTIVITIES





KALAHARI PLAINS CAMP

Wilderness Safaris - Adventures Camp



Kalahari Plains Camp lies in a remote part of the Central Kalahari Game Reserve, a place famed for its outstanding wildlife with vast herds of antelope followed by abundant predators – including the legendary black-maned Kalahari lions. This region also offers some of the best summer wildlife viewing in Africa.

The camp, situated on an immense pan, comprises ten en-suite canvas units each with a sleep-out area from which to enjoy the night skies. The lounge and dining area has a separate swimming pool and deck. The camp is raised off the ground to catch the breeze and take in the sweeping, spacious views across the Kalahari. Solar power provides electricity and hot water, and the innovative insulated canvas walls and roof keep the temperatures inside comfortable.

Guided game drives and walks (on request) unlock the wildlife treasures found here and San Bushman experiences provide insights into the unique culture of this people.



FACILITIES & ACTIVITIES



- AN INTRODUCTION TO - REPUBLIC OF THE CONGO

The sparsely populated Republic of the Congo is a surprising central African gem with seemingly endless pristine tropical forest and fingers of moist savannah covering its interior. Spared the conflict of neighbouring Democratic Republic of the Congo (DRC), and not having shared neighbouring Gabon's recent limelight, tourism to the Congo is at a fledgling stage with an aura of exploration and discovery enhancing every journey into its interior.

This little known former French colony holds approximately 3 million people, 70% of which live in the south-west in the urban centres of Brazzaville (the capital) and Pointe-Noire (the major port). This leaves the northern rainforest very sparsely populated and largely pristine. This is the heart of the Congo Basin, the world's second largest expanse of tropical rainforest, and, aside from a host of forest biodiversity, holds by far the majority of the world population of western lowland gorillas.

Rivers such as the Sangha, Mambili and the mighty Congo drain this basin and provide a means of exploration through dense forests and access to remote national parks such as Odzala-Kokoua, and Nouabale-Ndoki. It is in these areas that endemic wildlife flourishes and traditional forest dweller cultures persist.

The development of ecotourist camps in Odzala-Kokoua by the Wilderness Collection contributes to the conservation of critical elements of central African biodiversity. We believe Congo – with its low population, pristine ecosystem, spectacular biodiversity and stable democracy – is the best country in which to achieve this.



OUR CONGO AREA

Odzala-Kokoua National Park

Odzala-Kokoua in the north of Congo and on the Gabon border is one of Africa's oldest national parks, having been proclaimed by the French administration in 1935. It covers primarily pristine equatorial rainforest typical of the Congo Basin but is unique for protecting a large area of savannah as well. It is one of the 'gems' of west central Africa.

Within its 1 360 000 hectares (3 360 633 acres) it holds globally significant populations of western lowland gorilla, forest elephant and forest buffalo as well as a wide array of other species. It is renowned as the richest forest block in central Africa for primate species with eleven diurnal and six nocturnal species recorded. Guereza colobus, grey-cheeked mangabey, putty-nosed monkey and crowned monkey are perhaps the most common primates but De Brazza's monkey, northern talapoin and even chimpanzee are also all seen regularly.

It is for gorillas that people visit however, with densities of this great ape in Odzala the highest recorded in Africa. Sharing more than 97% of its DNA with humans, the gorilla is perhaps the most charismatic inhabitant of the forest, and guests at Odzala have a unique opportunity to observe habituated groups of the species.

M'boko Concession

In the south of Odzala-Kokoua our operation is focused in the M'boko area. This area is bounded by the Lekoli and Mambili Rivers – important waterways to negotiate the forest blocks – and plays host to several important bais, the productive forest clearings on which wildlife viewing is focused. As well as providing access to the primary forest blocks, rivers and bais, the M'boko area is also graced by a large tract of savannah, which plays host to additional biodiversity.

Ndzehi Concession

The Ndzehi Forest is situated adjacent to the western boundary of Odzala-Kokoua and is an area of primary rainforest mixed with marantaceae glades and drained by a few small, crystal-clear streams. As opposed to the sometimes swampy forests of the Lango area, this area is classified as terra firme forest and hosts high densities of both western lowland gorillas and chimpanzees.





LANGO CAMP

Wilderness Collection

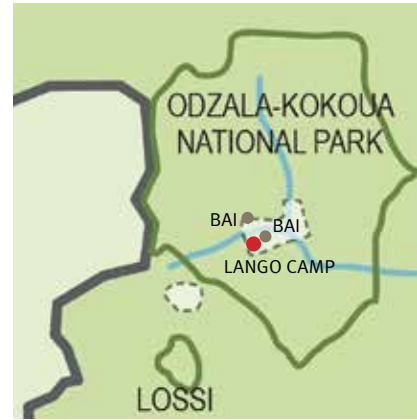

The beautiful Lango Camp is nestled in dense gallery forest overlooking the productive Lango Bai and strategically located to ensure access to a variety of habitats, activities and wildlife species.

Each of the six creatively designed guest rooms takes inspiration from the designs of the regional B'aka Pygmy groups and is raised three to four metres above ground to ensure views of part of the bai, as well as the surrounding gallery forest.



Floating wooden decks link the rooms to the main area, which is also fashioned from natural, locally sourced materials: sustainably harvested timber, bamboo and community-woven raffia palm roofing. A star deck and fire pit are placed on a dropped deck overlooking the bai for after-dinner relaxation and star gazing.

Most activities at Lango are a combination of walking and boating, while some driving is included, in search of species such as forest buffalo, forest elephant, sitatunga and harnessed bushbuck, as well as primates like Guereza colobus, grey-cheeked mangabey and putty-nosed monkey.



FACILITIES & ACTIVITIES



NGAGA CAMP
 Wilderness Collection



Ngaga Camp is an intimate six-unit lodge secreted within a glade in the primary forest above the Ngaga Stream and within the home ranges of several lowland gorilla groups.

Like Lango Camp, the six guest rooms are styled on traditional B'Aka architecture and use natural materials that blend into the forest environment. The slope down to the Ngaga Stream and the three- to four-metre high decking give each room a view right into the forest canopy and the passing bird and squirrel life.

Walkways lead through dense marantaceae vegetation to the central main area, which is sited at the crest of the glade looking into and above the rainforest, while a separate deck is located at a natural swimming spot on the Ngaga Stream below camp.

The principal activity at Ngaga Camp is the tracking on foot of habituated western lowland gorillas. These excursions are led by a guide and skilled local tracker who are able to follow signs on the forest floor, which lead them to the chosen gorilla group for the day. Birding and night walks are possible in search of various primate species as well as some spectacular forest birds.



FACILITIES & ACTIVITIES





- AN INTRODUCTION TO -
KENYA

Kenya, one of East Africa's premier safari destinations, covers an area of about 586 600km². Holding approximately 39 million people and over 40 tribes, Kenya spans the equator and is bordered by Tanzania, Uganda, Sudan, Ethiopia and Somalia. Its 550km coastline to the east is lapped by the warm Indian Ocean, with its highest point being Mount Kenya (5 199m).

One of Kenya's most spectacular geological features is the Great Rift Valley which passes through the country – an approximately 6 000km fracture in the crust of the earth running in a series of valleys from Syria to Mozambique.

Kenya's biodiversity is fascinating. Endless savannah plains and scorched deserts are interrupted by snow-capped mountains, cool highlands and equatorial forests. The scenic coastline possesses the atmosphere of a paradise island and is sprinkled with colourful coral reefs.

Annually, the country plays host to the remarkable phenomenon of the wildebeest migration, the largest single movement of herd animals on the planet. The open savannah grasslands also teem with plains game and roaming predators year-round. These diverse habitats offer endless opportunities for adventures, new discoveries and relaxation.



OUR KENYA AREA

Laikipia

Laikipia, located in the central highlands of Kenya, is considered the bountiful and fertile breadbasket of the Kenyan people. Four rivers, one of which is perennial, flow through the area making for an even more compelling habitat for animals and people alike. In these river valleys are to be found the sacred, preeminent fields of a nation still tied to agriculture, but which simultaneously strives to live in harmony with its wildlife.

Considered the gateway to Kenya's northern frontier country, wild and scarcely populated, much of Laikipia is covered by large privately owned ranches. On most ranches the cattle share the land with free-ranging wildlife. In recent years this wildlife has become a valuable asset, with many ranches establishing guest lodges, resulting in a hugely positive impact on the land, its wildlife and conservation. Importantly, community ranches have also been formed. Conserving more than just wildlife, these ranches are also a way of life and have bolstered a sense of local identity and strengthened community ties.

Segera

Centrally located within Laikipia, 20 000-hectare (49 000-acre) Segera consists of high altitude acacia grassland. Game roams freely and safely, their movements frequently monitored and documented; they are also protected by an efficient and well-organised anti-poaching unit. This area has become a sanctuary for elephant, lion, leopard, buffalo, eland and a wealth of plains game, including many endemic northern species such as the reticulated giraffe, Grévy's zebra and beisa oryx. More than 350 bird species have been recorded in the Laikipia area.

Moreover, Segera is a tangible example of successful multiple land-use efforts. With the support of the Zeitz Foundation, it is at the forefront of change in Kenya, with its vision to achieve a healthy, holistic balance of conservation, community, culture and commerce, leading to the creation of a sustainable Global Ecosphere Retreat that contributes to the vision of an ecosphere in the healthiest possible state.





SEGERA RETREAT

Wilderness Collection



Six timber and thatch villas project above a profusion of botanical life and from their raised wooden platforms gaze out onto the surrounding savannah, swingbeds below providing the perfect shaded midday relaxation. The sumptuous Segera House and perfectly-positioned Villa Segera boast similarly spectacular views and even greater privacy and luxury. Each villa includes in its décor original, individually selected paintings and other art from amongst Africa's most inspiring artists.



Overlooking snow-capped Mount Kenya, beautifully renovated stables form the core of the main area, filled with selected art of locally and internationally acclaimed African artists. Guests also have the rare opportunity to view the private collection of Segera's owner, including a number of striking sculptures that dot the botanical garden.

Activities are all facilitated through a Villa Attendant, are flexible and can be tailor-made to one's requirements and preferences. Guests are further spoiled for choice with a spa, gym and central pool. Meals and private dining are served al fresco or in the various reception rooms, the cuisine comprising Segera's own free-range beef and organic vegetables.



FACILITIES & ACTIVITIES





- AN INTRODUCTION TO -

MALAWI

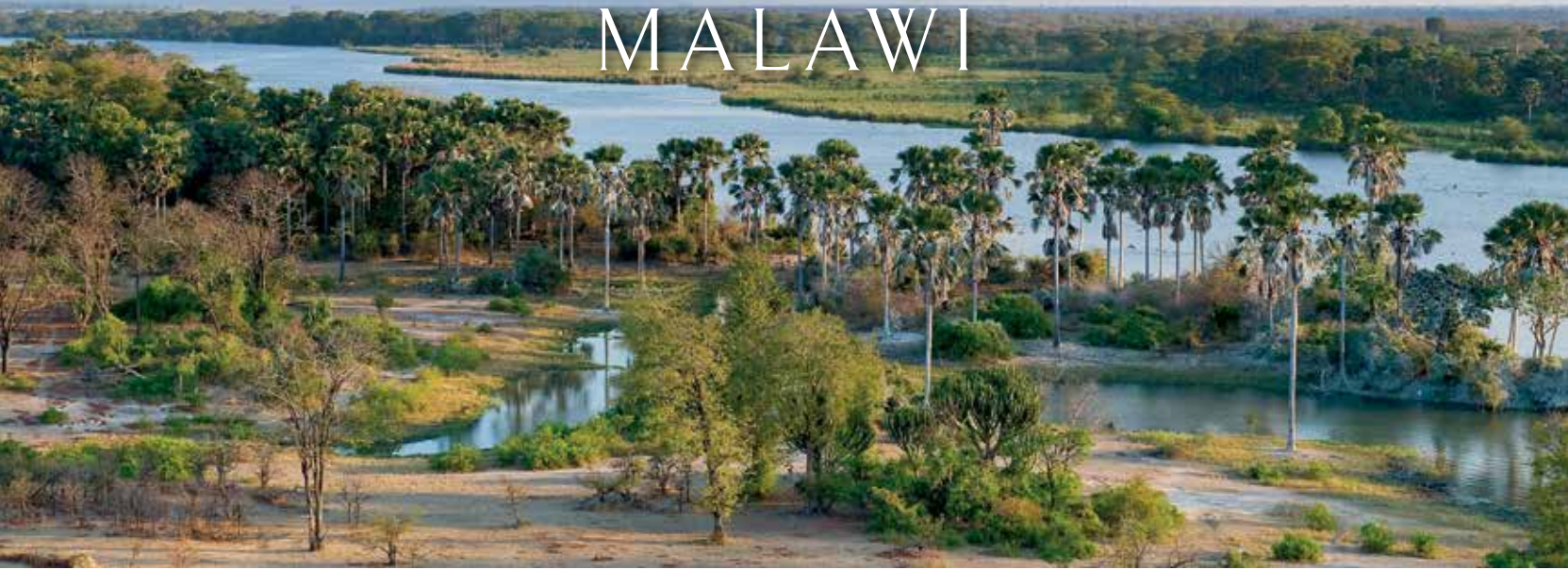

Malawi is a gem of a country in the heart of central southern Africa that offers a true African experience. Lake Malawi, the third largest water body in Africa, takes up almost a third of this narrow country.

Malawi's geography is sculpted by Africa's Great Rift Valley: towering mountains, lush, fertile valley floors and enormous crystal-clear lakes are hallmarks of much of this geological phenomenon – and Malawi displays them all. At its lowest point, the country is only about 35m above sea level; its highest point, Mount Mulanje, is over 3 000m above sea level. Between these altitude extremes, the country's diverse ecology is protected within Malawi's nine national parks and game reserves – everything from elephants to orchids. Malawi is also one of the best places in Africa for visitors to meet and interact with the local inhabitants or visit a rural community in an atmosphere totally devoid of either expectation or affectation.

This is a warm and welcoming country that offers visitors wonderful beauty, fascinating parks and some of the friendliest people in Africa. It is no wonder that it is known as the “warm heart of Africa.”



OUR MALAWI AREAS

Liwonde National Park

Liwonde National Park, covering 548km², is considered the most prolific wildlife area in Malawi. The Shire River – the country’s largest river and Lake Malawi’s only outlet – forms the Park’s western boundary and harbours a dense population of hippo, crocodiles and large numbers of elephant. Extensive floodplains surrounding the Shire sport dense riverine vegetation fringed by numerous borassus palms and baobabs. Antelope such as impala, waterbuck, reedbuck and bushbuck are plentiful along the banks. In the east, relatively dry mopane woodlands are interspersed with candelabra trees, an area favoured by buffalo, yellow baboon and Lichtenstein’s hartebeest. Sable occur at one of the highest densities in Africa and offer fantastic viewing, while one of only two breeding groups of black rhino in Malawi reside in the Park. Nearly 300 bird species occur here, with specials such as Böhm’s Bee-eater, Livingstone’s Flycatcher, Pel’s Fishing-Owl, Lilian’s Lovebird and Brown-breasted Barbet.



Lake Malawi National Park

Lake Malawi is famed for the abundance and diversity of its fish life and holds a greater array of freshwater fish species (over 1 000) than any other lake on Earth and more than all of Europe and North America combined. The majority of these are colourful fish called cichlids (their local name is mbuna) of which the Lake contains more than 400 types, 30% of all known species. Other fish species such as chambo form the primary protein source of the people that live on the lakeshore and beyond. Much of this astounding underwater diversity is protected within the Lake Malawi National Park at Cape Maclear in the southern part of the Lake, the first park in the world set aside for the protection of freshwater fish and a World Heritage Site.

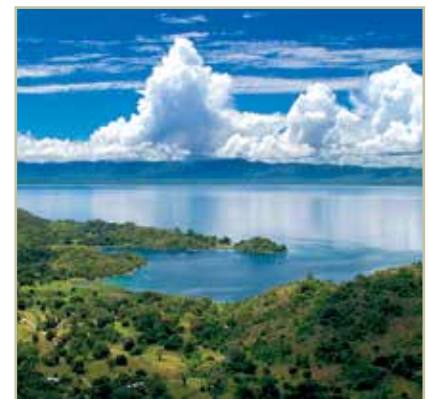

Lake Malawi - Central Lake Shore

At approximately 600km long and up to 80km wide, Lake Malawi constitutes roughly 20% of Malawi’s surface area. It dominates the eastern side of the country and harbours a wide range of underwater habitats. There are also a number of granitic islands dotted across the Lake while on its shores, fertile soils, lush woodland and baobabs occur amongst numerous fishing villages and mammals such as baboon, vervet monkey, rock hyrax, sun squirrel and hippo are frequently seen. Along the lakeshore, numerous bird species are found, particularly waterbirds. Nearby remnant patches of lowland forest harbour further exciting bird species including Grey-olive Greenbul and Narina Trogon. The central lakeshore is renowned for its golden beaches.



Nyika National Park

The 3 134km² Nyika National Park, Malawi’s largest park, is a wild, untouched and remote upland area, with the distinction of being the only big game Afro-montane area in south-central Africa. The vistas in this Park are immense with high-altitude grassland the most obvious feature of the Nyika Plateau. Isolated hills and ridges, and evergreen forest pockets bursting with endemism add further character to the rolling hills, whilst extensive swathes of broad-leafed miombo woodland dominate the lower slopes. Nyika is a botanist’s delight in summer with alpine flowers that include 11 localised orchid species, exquisite dieramas, gladioli, protea and kniphofia. Nyika also harbours important populations of roan, eland, Crawshay’s zebra, southern reedbuck, bushbuck, warthog, spotted hyaena and side-striped jackal. Elephant and leopard can be seen at times. Approximately 400 bird species occur in Nyika, many with highly restricted distributions, making it a key birding destination in Africa.





MVUU LODGE

Wilderness Safaris - Classic Camp



Mvuu Lodge overlooks a tranquil lagoon just off the Shire River with the main lounge area set high above the water in an area of captivating variety and beauty. It has an extensive wildlife library and telescope to make the most of the exceptional bird and other life that moves around the river. Mvuu means “hippo” in Tonga and the name epitomises the large numbers of pods of these water-loving mammals that float in the river. In this lush and fertile area, an excellent diversity of animals can be seen.



Accommodation comprises eight tents, one of which is a romantic honeymoon suite. Each tent has en-suite bathroom facilities and its own deck built to look over the water. Lodge facilities include a dining room, pub, lounge area and a swimming pool.

Activities include boating, walks, birding, and traditional game drives by day and night. The Rhino Tracking Experience is a three-hour guided walk, tracking black rhino and learning how they are monitored and conserved. No visit to Mvuu is complete without a visit to one of the villages on its boundaries.



FACILITIES & ACTIVITIES





MVUU CAMP

Wilderness Safaris - Adventures Camp



Mvuu Camp has a spectacular vantage point along the Shire River that draws all manner of fauna to its banks. The camp, comprising 12 units as well as a nearby campsite, is a clever mix of spacious stone and canvas chalets and specially designed family tents. An impressive thatched dining and lounge area offers a magnificent river vista that is framed by two large baobab trees. Dinners are sometimes held under the stars in a specially constructed boma. A custom-built education and conference centre with facilities for up to 40 delegates or smaller corporate and team building functions is available.



Mvuu Camp offers a wide range of options including camping, as well as full board rates and a variety of activities including boating trips on the Shire River, game drives, nature walks, a three-hour Rhino Tracking Experience (with 90% of the fee going to rhino conservation) and non-stop birding. Trips to nearby villages and Nanthomba School are also popular.



FACILITIES & ACTIVITIES





MUMBO ISLAND CAMP

Wilderness Safaris - Adventures Camp



Mumbo is a pristine island in Lake Malawi National Park which, with its crystal clear waters and innumerable species of cichlid fish, offers some of the best freshwater scuba diving in the world and the best snorkelling on the Lake.

The island lies 10km north-west of Cape Maclear, where reception and the nearest point of road access is located. The camp comprises five twin tents perched on rocks high above the water shaded by lush foliage, each with bucket showers, 'eco-loos' and wooden deck. A hammock provides a comfortable spot to take in the idyllic Lake view. A twin-tented family unit is tucked into the forest near the main beach. There is a dining area, bar and watersport gazebo of timber and thatch.



Activities here vary from lazing in a hammock to snorkelling, diving, swimming, kayaking, and birdwatching. Guests have the option of boating or paddling to explore the granitic islands of the Lake.

FACILITIES & ACTIVITIES

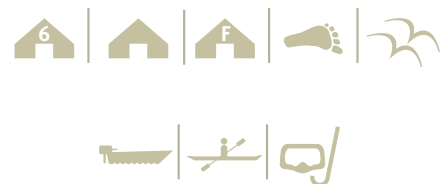



CHINTHECHE INN

Wilderness Safaris - Adventures Camp



Chintheche Inn on the western shore of Lake Malawi is known for its white sands, warm clear waters and age-old fishing villages. The area boasts some of the finest beaches on the entire lakeside and the distant Viphya Mountains form a dramatic backdrop.

The Inn is set in lush gardens with large, shady trees overlooking the Lake and comprises ten comfortably furnished en-suite rooms and a two-bedroomed family cottage. All open out onto a patio and grass lawns sloping to the beach and are tastefully furnished with colourful fabrics and local crafts. There is a central dining area and bar, and meals often take place (weather permitting) under the stars or in a shady corner of the garden. There is a large pool, and campsites are discreetly situated in the ample gardens.

Activities include excellent swimming, snorkelling, mountain biking, exciting birding and visits to local fishing villages and the nearby Bandawe Mission.



FACILITIES & ACTIVITIES



CHELINDA LODGE
Wilderness Safaris - Classic Camp



Chelinda Lodge offers spacious log cabins all with sweeping views over Nyika's rolling grasslands, which are often dotted with large herds of roan, eland and zebra. A pocket of hagenia woodland and forest backdrop perfectly shelters this idyllic upland camp.



Accommodation comprises eight warm log cabins made of pine with fireplace, en-suite bathroom and an upstairs viewing area or room for accompanying children. Two chalets are joined to form an interconnected family unit. Elevated wooden walkways link the cabins to the inviting main building, complete with outside deck for sundowners, convivial dining around a fireplace and lounge area for quiet reflection or conversation.

Activities include nature drives to discover the wonders of the Park, informative walks, birding, and mountain biking. Visiting Chelinda Lodge is an exciting component to any visit to Malawi and indeed to the subregion.



FACILITIES & ACTIVITIES





CHELINDA CAMP

Wilderness Safaris - Adventures Camp



Chelinda Camp, situated within Nyika National Park, overlooks a crystal-clear dam with views out onto the open grasslands of the High Nyika Plateau.

The camp has two types of accommodation. Four chalets each with two bedrooms, bathrooms, a lounge, dining area with fireplace, and small kitchen are ideal for private groups with their own guide; private meals can be enjoyed in the chalet. Six twin-bedded en-suite rooms with either a bath or shower are also available; guests here take meals in the nearby main area, which has a large dining, bar and lounge area complete with comfortable furnishings and an inviting fireplace.

This unique area is explored via day and night nature drives, walks and mountain biking. The area has a host of birding specials such as Bar-tailed Trogon, White-chested Alethe and Denham's Bustard.



FACILITIES & ACTIVITIES



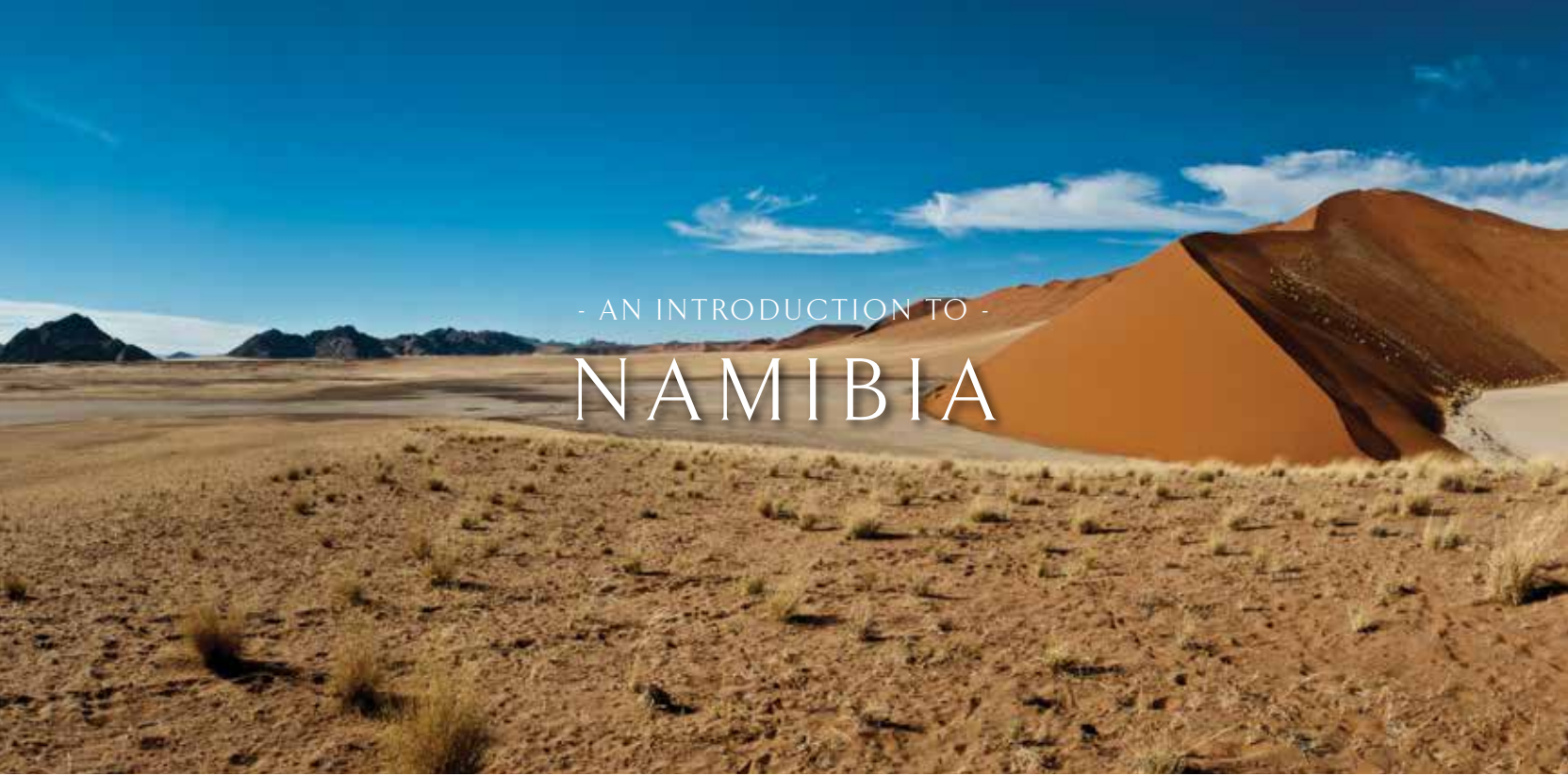

- AN INTRODUCTION TO -
NAMIBIA

Namibia is a country of astonishing contrasts aptly named after the Namib – the oldest desert on the planet, and a sea of red sand along the Atlantic coastline. Namibia is celebrated for its vast open landscapes, infinite supply of blue skies, sun-drenched weather and star-filled nights.

Over the years, there have been a number of cultural influences that have all added to the unique atmosphere of Namibia. At various times Germany, Great Britain and South Africa have all governed the territory, but it was with the eventual independence of Namibia in 1990 that the country was able to develop its multicultural character and reinvent itself. There is a distinctive Namibian character that freely blends African styles with European influences on architecture, food, customs and art.

All this is in interesting juxtaposition with the expansive landscapes that surround the cities. The many national parks and game reserves boast a huge variety of wildlife in a kaleidoscope of differing environments: the white salt pans of Etosha National Park; the red dunes at Sossusvlei; lonely beaches along the Skeleton Coast and the uninhabited wilderness of the Kunene Region. Astonishing contrasts are everywhere for the visitor to savour, enjoy and photograph.



OUR NAMIBIA AREAS

Sossusvlei

Sossusvlei, located in the red dunes of the Namib Desert, is formed where the natural course of the ephemeral Tsauchab River is blocked by a mass of sand. This mass of sand stretches for 400km south of Walvis Bay, sandwiched between the cold Benguela Current of the west coast and the escarpment that runs parallel more than 100km inland. The path of the Tsauchab is flanked by some of the tallest sand dunes in the world and then ends in a series of pans or vleis that dot the end of this blind river. Sossusvlei is one such pan, Dead Vlei another.



Kulala Wilderness Reserve

Kulala Wilderness Reserve, a 40 000-hectare tract of land near the spectacular sights of Sossusvlei, borders the expansive Namib Naukluft Park. Today, after ten years of habitat rehabilitation, Kulala is once again home to all forms of desert wildlife and provides convenient access to the splendour of the towering red dunes of the Namib. The Sossusvlei dunes rise dramatically more than 300 metres above the surrounding plains, and are surrounded by rugged, ancient volcanic mountains and open plains. Larger desert-adapted wildlife such as ostrich, springbok and gemsbok flourish here with carnivores such as bat-eared fox, Cape fox, brown hyaena and black-backed jackal often seen. Emphasis is placed on desert fauna, spectacular scenery and the incredible night sky. Unique birds include Dune Lark, Burchell's Courser, Ludwig's Bustard and Stark's Lark.



Kunene

The Kunene Region, formerly known as the Kaokoveld, is situated in north-west Namibia. It is one of the harshest environments on the planet, with endless vistas across stark plains, ancient valleys, rugged peaks and desolate coastline. The ephemeral rivers that bisect it form linear oases as they meander their way west towards the sea. The vegetation that fringes their courses provides sustenance to a diverse array of superbly adapted desert wildlife like black rhino, elephant, springbok, gemsbok, giraffe and Hartmann's mountain zebra. The most reliable source of water here is the fog created when the icy Atlantic waters meet the warm air of the coast.



Doro !Nawas Conservancy

The 407 300-hectare Doro !Nawas Conservancy is a landscape ranging from boulder-strewn plains to curious rock formations surrounded by sand dunes. This is prime desert-adapted elephant territory, where herds traverse the Aba-Huab riverbed seasonally in search of water and vegetation. Wildlife viewing concentrates along the riverbed and valleys. While there are no large concentrations of wildlife, this arid environment is home to gemsbok, springbok and variety of other species, including occasional black rhino and cheetah. Birdlife is excellent with several Namibian endemics such as Monteiro's Hornbill and Rüpell's Korhaan. Africa's largest collection of petroglyphs (prehistoric rock engravings) and San rock art are to be found at Twyfelfontein, Namibia's first World Heritage Site.



Torra Conservancy

The 352 200-hectare Torra Conservancy has a landscape characterised by hills interspersed with valleys and dry riverbeds. Early morning fog brings precious water to flora and fauna, which have adapted superbly to this harsh environment. Despite its aridity, the area supports a surprisingly high diversity of wildlife including a healthy number of desert-adapted elephant and good populations of giraffe, gemsbok, springbok, occasional cheetah and black rhino as well interesting flora like euphorbias, pachypodiums and shepherd's trees. Birding is excellent with White-tailed Shrike and Benguela Long-billed Lark common finds. The conservancy is the result of a successful partnership between Wilderness Safaris and the local Torra community that has become an inspiration for communities and conservationists throughout Africa.



Palmwag Concession

The 450 000-hectare Palmwag Concession is made up of rolling, rocky hills, flat-topped mountains with scattered euphorbia, and stark plains with ancient welwitschia plants, scrubby vegetation and isolated clumps of trees. The conservancy supports the largest free-roaming population of desert-adapted black rhino in Africa as well as a healthy number of desert-adapted elephant. Thanks to the freshwater springs in the area there is a surprising amount of life here: Hartmann's mountain zebra, giraffe, gemsbok, springbok and kudu, as well as lion, cheetah, leopard, and brown and spotted hyaena. Birdlife is equally varied including endemics like Bokmakierie and Rüppell's Korhaan. Palmwag holds the core of the rarely seen desert-adapted lion population of north-west Namibia.



Marienfluss Conservancy

In extreme northern Namibia, mountains of folded metamorphic rock are severed by the Kunene River that forms the border between Namibia and Angola. The Kunene River, the only permanent source of water in the region, is lined with a narrow belt of riverine vegetation and palm trees. Away from the river the vast Marienfluss and Hartmann's Valleys, that in rainy years become grassy expanses, comprise part of the vast 303 400-hectare Marienfluss Conservancy. Generally their flat topographies are covered by soft sand broken only by a few tough grasses, toxic euphorbias, mysterious 'fairy circles' and sheer granite Inselbergs. Wildlife such as gemsbok, springbok, brown hyaena and Cape fox occur sporadically, while the smaller creatures impress within this surreal setting. The Kunene River also harbours Nile crocodile and vibrant birdlife.



Etosha

Etosha Pan is the result of a geological shift that dramatically changed the course of the Kunene River. Its 5 000km² (120km across and 55km from north to south) were formerly an ancient lake. Today the Pan is mostly bone dry, the stark, parched white surface giving the Pan its Herero name – "Great White Place". The edges of the Pan give way to a surprising variety of vegetation types: from woodland and broad swathes of mopane, to open acacia-strewn plains and grasslands. Fringing the Pan are a number of productive waterholes that sustain the high density of large mammal fauna, from elephant and lion to vast herds of springbok, wildebeest, zebra, giraffe and gemsbok.



Ongava Game Reserve

On the southern boundary of Etosha National Park and forming a buffer to the Park lies Ongava Game Reserve, a 30 000-hectare private reserve. It is a haven to large concentrations of wildlife: notably lion, wildebeest, springbok, gemsbok, Hartmann's mountain zebra, red hartebeest, giraffe, eland and the largest population of the endemic black-faced impala outside of Etosha. The Reserve is also known for the successful reintroduction of white and black rhino. Bird life is prolific with 340 species seen, amongst them ten of Namibia's 14 endemic bird species including White-tailed Shrike, Short-toed Rock Thrush, Hartlaub's Francolin, Rüppell's Parrot and raptors in abundance. Ongava also provides easy access to the prime game viewing areas of western Etosha, Namibia's premier wildlife destination.





LITTLE KULALA

Wilderness Safaris - Premier Camp



This acclaimed desert retreat is situated amongst camel thorn trees on the dry Auab riverbed in the Kulala Wilderness Reserve. The 11 climate-controlled, thatched villas merge seamlessly into the timeless desert landscape, with exquisite fittings and fixtures and innovative bleached decks each with a private plunge pool. The extensive use of neutral colours, gorgeous textures and natural light reproduce the soothing pastel tones of the desert. Each villa has a rooftop 'skybed' for romantic stargazing, with both indoor and outdoor showers. An elegant entertainment area includes al fresco fine dining as a highlight.



Varied activities aim at acquainting guests with the splendour, solitude and stark beauty of the Namib Desert, with excursions to Sossusvlei (via our own private gate), and nature drives and walks providing awe-inspiring views of desert-adapted wildlife and plants. A balloon safari at extra cost offers a unique experience soaring silently above the desert, while eco-sensitive quad biking takes place at one of the nearby camps.



FACILITIES & ACTIVITIES





KULALA DESERT LODGE

Wilderness Safaris - Adventures Camp



Hidden at the foot of the majestic Sossusvlei dunes, a private entrance to Namib Naukluft Park makes Kulala Desert Lodge the closest location to Sossusvlei, while magnificent views of its famous red dunes, mountainous scenery and vast open plains make it the most spectacular.

The camp comprises 23 thatched and canvas “kulalas” with en-suite bathrooms and verandas. Each unit is built on a wooden platform to catch the cooling breezes and has a deck on the flat rooftop where bedrolls are placed for guests to sleep under the stars. The main area, with northern African-inspired décor, has a lounge, dining area, pool, and wraparound veranda overlooking a waterhole. Activities impress guests with the overwhelming magnitude, solitude and tranquillity of the desert and include private tours to Sossusvlei, as well as horse riding, hot air ballooning and eco-sensitive guided quad-biking, scenic nature walks, and drives to view the desert’s fascinating flora and fauna (at extra cost).



FACILITIES & ACTIVITIES





DAMARALAND CAMP

Wilderness Safaris - Classic Camp



Damaraland Camp is situated in the Huab River Valley in one of the best wilderness areas in Namibia, offering endless vistas across stark plains, ancient valleys and a stunning ochre-purple mountain backdrop. Ten large en-suite, adobe-style thatched units are raised off the ground, each with a walk-in dressing area and a large deck on which to sit and contemplate the desert. The spacious living area comprises a dining area, and swimming pool. New technology combined with ancient knowledge has produced an eco-friendly yet high-performance design in this unique camp. An open campfire and outdoor 'boma' are enjoyed during calm evenings and stargazing is superb, thanks to the crystal-clear night skies.



Activities include nature drives and walks during which guests can see species such as desert-adapted elephant, gemsbok, kudu and springbok, and black rhino as well as rare succulent plants. Further afield, ancient rock art and the Petrified Forest are just some of the geological wonders in the area.

Damaraland Camp is the result of an award-winning partnership between Wilderness Safaris and the Torra Conservancy.



FACILITIES & ACTIVITIES





DORO NAWAS CAMP

Wilderness Safaris - Adventures Camp



Doro Nawas rests on the slopes of a small hill on the edge of the dry Aba-Huab River overlooking ancient plains with glorious views of the rugged Damaraland area. Guests are housed in 16 natural walled units, the design and décor blending in with the surrounding scenery. Each unit consists of a bedroom, en-suite bathroom, outdoor shower, and veranda for stargazing or sleep-outs. There are indoor and outdoor dining areas, a residential pool area and a small curio shop.

The camp provides an excellent base for exploring the local area in game drive vehicles and on foot, combining a luxury safari experience with economic empowerment for the local community. Guests can view petroglyphs – prehistoric rock engravings – and San rock art at Twyfelfontein, Namibia’s first World Heritage Site. The combination of Africa’s past and present makes Doro Nawas a fascinating visit.

Doro Nawas Camp is a joint venture between Wilderness, the Doro !Nawas community and a Namibian empowerment company.



FACILITIES & ACTIVITIES





DESERT RHINO CAMP

Wilderness Safaris - Classic Camp



Desert Rhino Camp offers an original and exclusive wilderness experience and the possibility of seeing some of the largest free-ranging population of desert-adapted black rhino in Africa. The camp, set in a wide valley sometimes flush with grass, has eight large Meru-style tents with en-suite bathrooms. A tented dining and living area and plunge pool offers uninterrupted views of the desert and mountains, while extraordinary welwitschia plants dot the plain in front of camp.



Activities include rhino tracking on foot and by vehicle with Save the Rhino Trust trackers (an NGO responsible for the conservation of the black rhino in the area), full-day outings with a picnic lunch, birding and nature drives. Other species seen in the area include Hartmann's mountain zebra, giraffe and lion. Desert Rhino Camp is run in conjunction with Save the Rhino Trust so in addition to gaining amazing insight into the ecology and conservation of this area, a portion of guest revenue goes to the Trust and its conservation operations.



FACILITIES & ACTIVITIES





HOANIB SKELETON COAST

Wilderness Safaris - Classic Camp



Located in the most remote part of the Kaokoveld – a land of mountains, vast plains, and dry riverbeds inhabited by fascinating wildlife – Hoanib Skeleton Coast lies on the transient Hoanib River. Just seven twin-bedded tents and one family unit with en-suite bathrooms look out over rugged scenery.

The area is explored by vehicle, on foot and in the air (weather permitting), with game drives discovering the wealth of desert-adapted life: elephant, giraffe and antelope followed by lion, leopard and cheetah. Guests can unravel the enigmatic history of the original Strandlopers (“Beachcombers”), their stone circles lying in hidden valleys, marvel at the ancient welwitschia plant, follow the great herds and savour landscapes that unfold untouched for hundreds of kilometres.

Further afield, guests can meet members of the semi-nomadic Himba people and other communities. Hoanib Skeleton Coast is a joint venture with the neighbouring Community-based Conservancies of Anabeb, Torra and Sesfontein.



FACILITIES & ACTIVITIES





SERRA CAFEMA CAMP

Wilderness Safaris - Premier Camp



Set amongst shady trees on the banks of the Kunene River, Serra Cafema is one of the most remote camps in southern Africa, its Portuguese name originating from the mountains that dominate the northern skyline. Guests fall asleep to the sound of rushing water, while by day they explore one of the driest deserts in the world.



The camp's eight unique canvas and thatched chalets, each with its own en-suite bathroom, show great attention to detail; the elevated decks and simple structures of wood, canvas and thatch create a camp that is at one with its surroundings. The dining room and pool look out over the Kunene River.



Activities here are varied, including boating (seasonal), walking, viewing breathtaking landscapes, as well as carefully guided quad-bike excursions that tread lightly on the dunes. In this isolated region, the Himba people continue their nomadic, traditional way of life and when in the area, offer guests the opportunity to learn about their lifestyle and traditions.

FACILITIES & ACTIVITIES





LITTLE ONGAVA

Wilderness Safaris - Premier Camp



Little Ongava is perched on the crest of a hill commanding magnificent vistas of the plains beyond. Arguably Namibia's most civilised and certainly most comfortable accommodation, Little Ongava offers an extraordinary experience as the focal point of an Etosha journey.

This intimate camp has only three spacious suites each with its own plunge pool, en-suite bathroom, 'sala', and outdoor 'al fresco' shower. These and the lounge and dining area have wonderful views of the waterhole below the camp and the latter lends itself to relaxed, stylish dining under the African sky. Guests at Little Ongava share a dedicated guide and vehicle, ensuring the best possible nature experience at one of Africa's great wildlife destinations. Day and night wildlife-viewing drives, visiting hides overlooking waterholes, walks and rhino tracking with experienced guides can all be enjoyed exclusively on this reserve. Game drives and day trips into nearby Etosha National Park are also offered.



FACILITIES & ACTIVITIES





ONGAVA TENTED CAMP

Wilderness Safaris - Classic Camp



Ongava Tented Camp is tucked into a hidden valley at the foot of a dolomite hill in Ongava Game Reserve bordering Etosha National Park. Eight large comfortable Meru-style tents all have en-suite facilities, open air showers and private verandas; the family unit sleeps four. The main area, built of stone, canvas and thatch, fronts onto a much-frequented waterhole; watching wildlife coming to drink from here or from the swimming pool is a favourite pastime.



Ongava's proximity to Etosha allows for game drives in the National Park and on the Ongava Reserve itself. Other possibilities include guided walks, birding and spending time in hides. Ongava holds one of the largest rhino custodianships for the Namibian government in the country and is one of the few private game reserves in southern Africa where guests can see both black and white rhino.



FACILITIES & ACTIVITIES





ONGAVA LODGE

Wilderness Safaris - Classic Camp



The well-established Ongava Lodge is situated along the southern boundary of Etosha National Park in the privately owned Ongava Game Reserve. Situated as it is close to the top of a hill in the foothills of the Ondundozonanandana Mountain Range, the vantage point is beautiful and overlooks a well-frequented waterhole and the plains beyond.

Ongava Lodge offers luxury accommodation in 14 rock and thatch en-suite chalets. There are impressive views over the camp's waterhole from the main lounge and dining areas and there is also an inviting pool to cool off in the heat of the day. Meals are either served in the main dining area under thatch or on the dining deck under the stars.

Activities include game drives into Etosha, visiting hides, and nature drives and walks on the reserve. Ongava has resident white and black rhino, giving guests staying at Ongava the opportunity to see both species.



FACILITIES & ACTIVITIES





ANDERSSON'S CAMP

Wilderness Safaris - Adventures Camp



Nestled in mopane scrub on white calcrete soils, Andersson's Camp is situated 4.5km from Etosha's Andersson Gate. The camp was named after Swedish explorer Charles Andersson – one of the first Europeans to 'discover' Etosha, Africa's largest saltpan.

The resurrected former farmstead that stands on the site now forms the centre of a charming camp fronting onto a productive waterhole. The 20 tented en-suite units are raised on decks for an enhanced view of the waterhole and surrounding plains. The camp is an exciting example of sustainable construction; this model of eco-sensitive lodging provides an authentic, safe and down-to-earth experience for small groups, families and independent travellers to the Etosha region and is easily accessible by either road or air.



Activities include day and night game drives and nature walks around Ongava Game Reserve, as well as day trips into Etosha.



FACILITIES & ACTIVITIES





- AN INTRODUCTION TO -
SEYCHELLES

The Republic of Seychelles is a cluster of 115 islands across 950 000km² of Indian Ocean off Africa's east coast. Lying just south of the equator and beyond the cyclone belt, surrounded by warm waters, Seychelles epitomises the expression 'tropical island paradise'.

Seychelles is divided into 43 Inner Islands – the only oceanic islands of granitic composition on Earth – and the Outer Islands – five groups of flat, low-lying coral atolls and reef islets. The most famous is Aldabra atoll, the world's largest raised coral atoll and a World Heritage Site where over 150 000 giant tortoises live. The Seychellois themselves call their home "Forever Eden" and for good reason. More than 1 000 flowering plant species and over 220 bird species are recorded, and insects, amphibians and reptiles abound – amongst them the smallest frog and the largest land tortoise in the world. Mammals are less abundant as befits island ecosystems, with the most common being the famous flying fox, a large fruit bat. Tourism is the mainstay of the nation's economy, benefiting from policies that take into account both the conservation of natural and cultural resources as well as the carrying capacity of the islands.



OUR SEYCHELLES AREA

North Island

Some 30km from the main island of Mahé, the 210-hectare Ile du Nord, or North Island, comprises three granite outcrops with a tropical interior of coconut palms and takamaka trees. After a ten-year comprehensive rehabilitation and conservation plan known as the 'Noah's Ark Project', North Island has begun to reclaim itself.

More than 200 plant species have been identified in 16 different habitat zones and a number of endemic invertebrates and reptiles thrive. Seychelles Blue Pigeons and Seychelles Sunbirds, rare or absent in 1997 when Wilderness Safaris acquired the island, are now relatively common and together with the Seychelles Kestrel, Seychelles Swiftlet and introduced Seychelles White-Eye comprise the five endemic bird species present. Emerging from the ocean to nest on North Island's beaches in growing numbers are endangered green and hawksbill turtles. Endemic day geckos with fluorescent orange markings clamber over surfaces while Seychelles fruit bats, the so-called flying fox, are often seen.

The warm, clear waters surrounding the island are filled with an abundance of sea life. Hard and soft corals litter the ocean floor, nudibranches are often seen and hugging the reefs is an endlessly colourful array of fish such as spotted eagle rays, parrotfish, round ribbontail rays and white-tip reef sharks. Many members of the kingfish family, giant barracuda, wahoo, and sailfish move through the depths. Whale sharks and giant sleepy sharks are seasonal, and awe-inspiring, visitors to the area.

We are most proud of this ecotourism development, one that has allowed Wilderness to meaningfully advance the renewal of this vital, verdant Noah's Ark, afloat in the Indian Ocean. Today, North Island and its ecotourism development are an example of the ecologically sensitive utilisation and rehabilitation of a precious natural treasure.





NORTH ISLAND

Wilderness Collection



North Island is a place of barefoot luxury for those seeking an unspoilt, spectacular tropical retreat. There are only 11 individually handcrafted guest villas on the entire island, each constructed to create a sensorial experience in surroundings of understated elegance and providing a unique atmosphere and distinct flavour of the Seychelles. Each villa has a study or second bedroom, creating the perfect space for children. All the villas are built directly on the eastern beach.



A lounge, dining room and library, scenically located health spa and gym, world-class dive centre, and a rim-flow swimming pool are all built into a granitic outcrop. A sunset bar and restaurant are tucked away on the western beach of the island. Activities include mountain biking, gym, guided walks, snorkelling, fishing, boating, sea kayaking, and scuba diving. North Island has created a signature style that combines natural beauty with sheer luxury, a rare experience in harmony with the environment. It is thus an example of a sustainable ecologically-sensitive utilisation of a precious natural treasure.



FACILITIES & ACTIVITIES





- AN INTRODUCTION TO -
SOUTH AFRICA



Situated at the southern edge of the African continent, South Africa is bounded by oceans on three sides with an interior characterised by an assortment of habitats, from lush tropical forests to arid deserts, mountains to open bushveld savannah. Since the first democratic elections in 1994, South Africa has become one of the world's top travel destinations, blending elements of both 'Africa of old' with modernity: wilderness areas contrasting with modern cities. Kruger National Park is world famous as a premier wildlife and bird viewing destination, while the coastline offers superb vistas – such as sandy beaches and sheer, forest-covered cliffs – and amazing marine encounters, from southern right whales to pristine coral reefs. This diversity is echoed in the country's peoples and history. The first human inhabitants – the San or Bushman people – and the powerful civilisations of Mapungubwe and Thulamela who traded with Chinese and Arab traders a thousand years ago have given way to a 21st-century country filled with a colourful mixture of people and cultures, a heady history and a natural heritage that has South Africans proudly describing their land as “a world in one country.”



OUR SOUTH AFRICA AREAS

Kruger National Park – Makuleke Concession

At two million hectares and over 300km long from north to south, the Kruger National Park is a savannah landscape with 147 mammal species, over 400 bird species and numerous reptiles, amphibians and insects. In the extreme northernmost sector between the Limpopo and Luvuvhu Rivers lies the Makuleke Concession, with Mozambique and Zimbabwe to the east and north. Although this 24 000ha area comprises only fractionally more than 1% of the total area of the Kruger, 75% of all species in this region occur here, making it one of the Park's biodiversity hotspots and a true contrast to the rest of Kruger. Scenically, the area is stunning, with mountains, gorges, forests of fever trees, squat baobabs, mopane woodland, and open savannah grassland. This range of habitat is home to large herds of elephant and buffalo, predators such as leopard and lion, the highest density of nyala in Kruger, and species difficult to find further south, such as eland, Sharpe's grysbok and yellow-spotted rock dassie. The area is known as a birding Mecca with some species found nowhere else in South Africa, such as Böhm's Spinetail, Racket-tailed Roller and Three-banded Courser. The biological significance of the Concession was recognised in its declaration as a Ramsar Site – a wetland of international importance. A visit here is a spectacular Kruger experience.



iSimangaliso Wetland Park – Rocktail Bay

Rocktail Bay is situated in Maputaland on KwaZulu-Natal's north-eastern seaboard, a diverse region of forested dunes, wetlands, sandy beaches, woodlands and warm seas. It lies within the iSimangaliso Wetland Park, one of South Africa's World Heritage Sites which spans a range of ecological zones. Situated offshore is the Maputaland Marine Reserve which offers an additional sanctuary with extraordinary diving and snorkelling encounters with prolific marine life, spectacular coral landscape, and dolphins and whales. Few sections of the South African coastline are as unspoilt and secluded, and the area is known for its superb, pristine dive spots as well as the Loggerhead and Leatherback turtles that come to lay their eggs and hatch on the beaches. The land is a low-lying coastal plain, lined with ancient coastal dunes that are considered to be amongst the tallest vegetated dunes in the world and are swathed in lush green forest with a variety of animals, birds and plant life that provide a natural counterpoint to the bushveld. Common reedbuck frequent the marshes and grasslands, red duiker live in the forest areas, hippo are found in freshwater lakes and whales and dolphins are often seen offshore. Birding is outstanding, with a number of typical coastal forest species – Green Twinspot, Green Malkoha, Grey Waxbill, Purple-crested and Livingstone's Turacos.

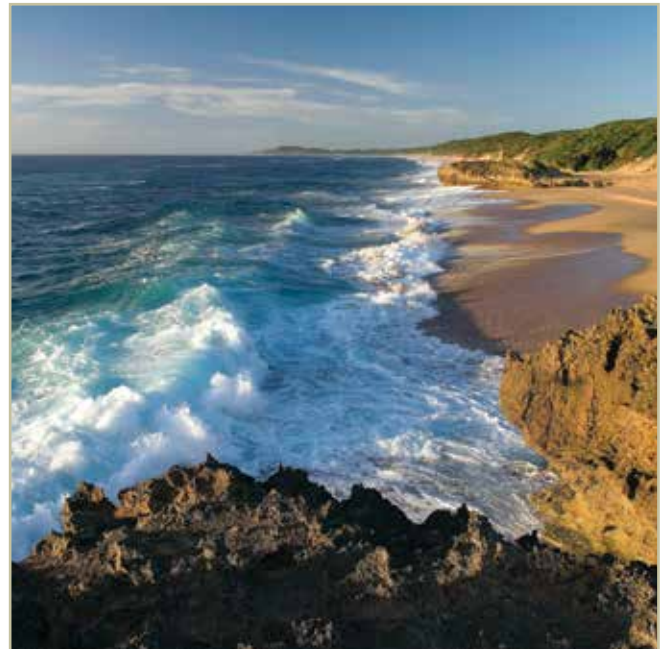



PAFURI CAMP

Wilderness Safaris - Adventures Camp



Pafuri Camp lies along a bend of the Luvuvhu River shaded by enormous jackal berry and nyala berry trees. Its 20 tents are en-suite under thatch with indoor and outdoor showers. The main area, with its large decks, open-sided lounge and dining rooms and swimming pool, is perfect for relaxing and watching the wildlife drawn to the Luvuvhu to drink. The colourful fabrics reflect the culture of the Makuleke community with whom Wilderness Safaris has partnered at Pafuri. The camp and its walkways are raised off the ground, allowing wildlife to move undisturbed to and from the river.



The Makuleke Concession is explored through a variety of activities, ranging from game drives in open vehicles to walks and trails. It ideally complements the scenery, experience and game viewing offered in central and southern Kruger.



FACILITIES & ACTIVITIES





ROCKTAIL BEACH CAMP

Wilderness Safaris - Adventures Camp



Rocktail Beach Camp, set back in the lush dune forest, has 17 en-suite rooms, seven of which are family suites each with a shared bathroom and two bedrooms. A honeymoon suite has wonderful views over the ocean and forest. There is a central dining and lounge area with large wrap-around veranda and a raised deck with wide views extending out to the ocean. A large pool, curio shop and children's playroom complete the main area.

World-class diving is conducted along coral reefs accessible only to Rocktail guests. Other adventures include birding, swimming and walking in the forest and along remote beaches. Excursions are available (at extra cost) to Lake Sibaya, the surrounding community and Gugulesizwe, a joint venture between Wilderness Safaris and the community, where Sangoma visits and quad biking are on offer. During summer guests can accompany nightly research drives to monitor turtle nesting numbers and behaviour. The sight of a 750kg leatherback turtle heaving herself up the beach to lay eggs is a once-in-a-lifetime spectacle.



FACILITIES & ACTIVITIES



- AN INTRODUCTION TO -
ZAMBIA



Zambia is a vast country, friendly and peaceful, that offers superb wildlife and cultural encounters. Landlocked in south-central Africa, it is one of the region's least travelled and most rewarding wilderness destinations.

Situated mainly on a vast plateau 3 000m above sea level, the country boasts the Zambezi, Kafue and Luangwa rivers as well as Victoria Falls, one of the largest waterfalls in the world, which it shares with neighbouring Zimbabwe. Most of the country enjoys a mild, pleasant climate with the river valleys hotter and more humid and the north, in the region of Lake Tanganyika (one of Zambia's ten large lakes), tropical. While Lusaka is the country's capital, Livingstone, just 10km from the Falls, is the well-known 'adventure capital', offering adrenalin-packed activities on and around the Falls and the Zambezi River.

When it comes to wildlife, Zambia offers impressive diversity as well as large concentrations and numbers, and some of the wildest and most remote game areas on the continent. It was in Zambia that the concept of walking safaris originated as the best way of enjoying the rich flora and fauna of the country's 19 national parks. Birdlife is particularly prolific, attracting birders from all over the world.

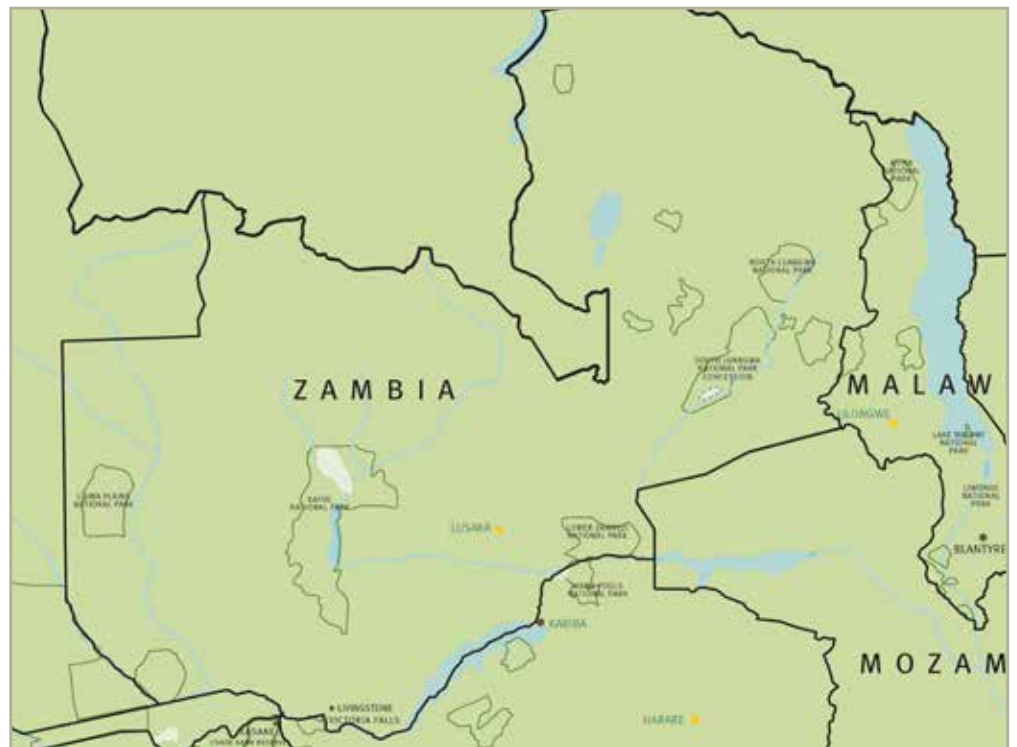

OUR ZAMBIA AREAS

Kafue National Park

At 22 500km², Kafue National Park is one of the largest in Africa. The million-hectare northern sector is the perfect location for our camps: remote, wild and diverse with vast tracts of pristine wilderness. The north-west is dominated by the Busanga Swamps, a papyrus-dominated wetland that gives way to the vast floodplain of the Busanga Plains, seasonally-inundated grassland dotted with isolated tree-islands. The Lunga, Lufupa and Kafue Rivers are lined with riverine forest and the landscape is further patterned with broad-leaved miombo woodland, open plains, floodplains and island thickets. The Busanga Plains offer concentrations of common species such as puku, lechwe, buffalo and wildebeest, but also comparative rarities not easily viewed in southern Africa such as roan, oribi and Lichtenstein's hartebeest. There is a high density of lion, with species like cheetah and wild dog utilising those areas where lion are not present. Birdlife is equally abundant and includes many 'specials' such as Ross's Turaco and Locust Finch.



South Luangwa National Park

The 9 050km² South Luangwa National Park is found in the low-lying productive Luangwa Valley. Our Luamfwa Concession, pristine and secluded, is situated in the remote and undeveloped southern sector of the Park. The Park is sustained by the Luangwa River, an impressive watercourse that supports high densities of game along its banks. Over time, the river's course has carved a multitude of channels that, in winter, form lagoons and oxbow lakes, which serve as magnets for game activity. The Luangwa is flanked by mopane woodland, scrub, savannah and low hills. Over 60 large mammal species are found: herds of elephant and buffalo frequently dominate access to water at the oxbow lakes, while puku, impala, waterbuck, warthog and kudu are prolific. Unique subspecies of wildebeest (Cookson's) and giraffe (Thornicroft's) occur only in the Luangwa Valley. Lion viewing is excellent and Luangwa is renowned for one of the highest leopard densities in Africa. Over 400 bird species have been recorded and local specials include Lilian's Lovebird and Racket-tailed Roller. The area is perhaps even better known for pioneering walking safaris.



Victoria Falls (Livingstone)

One of the Seven Natural Wonders of the World, Victoria Falls is known locally as Mosi-oa-Tunya – “the Smoke that Thunders” – a name that accurately depicts the plume of spray, visible for some distance, caused by the cascading waters of the Zambezi River. This is an area of spectacular scenic beauty: from the Falls themselves to the broad, picturesque course of the Zambezi River upstream. Wildlife also abounds in the area, particularly during the dry season, and can be viewed while boating on the river or on game drives in the Mosi-oa-Tunya National Park upstream of the Falls. This small park offers excellent sightings of buffalo, giraffe, zebra, wildebeest, impala and even white rhino. There is rich birdlife here too, including sought-after species such as African Finfoot, Half-collared Kingfisher, African Skimmer, Schalow's Turaco and Rock Pratincole. The principal town on the Zambezi's Zambian bank is Livingstone, which, with its adrenalin sports such as abseiling, white-water rafting and canoeing, has become known as the 'adventure capital' of southern Africa.





SHUMBA CAMP

Wilderness Safaris - Premier Camp



Shumba Camp is situated in the centre of the Busanga Plains close to permanent water and within easy access of the teeming floodplains. Shumba is named after a favourite species in the area: its large prides of lion. Viewing of game species is possible from the comfort of the tent or main deck, while the camp's fig trees ensure both shade and constant bird activity.



Shumba Camp comprises six spacious luxury safari tents, all on raised platforms with spectacular views. The dining area is elevated so as to take in this vista and each morning's sunrise; dinner takes place either here or in the cosy boma where guests can also enjoy elements of local Zambian culture.

Guests have the option of game drives in and around the Plains and water-based activities when the Plains are still inundated, while night drives provide the added excitement of the nocturnal wonders of the area.

FACILITIES & ACTIVITIES





BUSANGA BUSH CAMP

Wilderness Safaris - Classic Camp



Busanga Bush Camp lies in the heart of the Busanga Plains, a vast mosaic of expansive, grassy seasonal floodplains that extends to the horizon. The camp, nestled in a vegetated island of fig trees, can accommodate eight guests in four well-appointed tents. The lounge area is under canvas looking out over the plains; breakfast is often served here to take in the view of herds of lechwe and puku. The dining area lies under the shady canopy of a majestic tree from which an unusual lantern chandelier hangs, romantically lighting up dinner; most meals are served in the open air.

Activities include game drives, walking safaris and night drives, led by qualified guides. Thanks to the rising mist off the floodplains as they dry up in winter, guests can experience incredible sunrises and sunsets, with the sun a spectacular pink colour, while the floodplains teem with wildlife and birds.



FACILITIES & ACTIVITIES





KALAMU LAGOON CAMP

Wilderness Safaris - Classic Camp



The remote Luamfwa Concession is a wildlife paradise that offers unique bird watching and exciting game viewing. Puku, impala and common waterbuck are the most conspicuous mammals. Lion, spotted hyaena, leopard and crocodiles head the food chain and a plethora of hippo congregate in the Luangwa River. Elephant, yellow baboon and buffalo are also seen regularly.



Kalamu Lagoon Camp's dining area lies under a canopy of giant ebony trees overlooking a beautiful permanent lagoon just off the Luangwa River. A pool and viewing deck area located to the side of the camp offer spectacular views of the lagoon. Accommodation consists of eight safari-style reed and canvas tents, each en-suite with both an indoor and outdoor shower.

The Park is also renowned as the best walking destination in Africa and the Luangwa riverine vegetation and adjacent dambos can be explored on foot. Other activities include day and night game drives.



FACILITIES & ACTIVITIES





THE RIVER CLUB

Wilderness Safaris - Classic Camp



The River Club overlooks the Zambezi River, 18km upstream from Victoria Falls. Its main area is a well-appointed Edwardian house with lounge, dining room, library, shop and veranda on which breakfasts and teas are taken. Middy meals are often served on manicured lawns complete with croquet court. The gazebo and the Summer House (with snooker room) are both alternatives for private dining. The pool seems part of the river itself, a secluded deck provides respite and beauty treatments are available in the Wellness Centre. For the energetic the gymnasium, running track on the secure property and all-weather tennis court are perfect. Ten luxury en-suite chalets are screened, air-conditioned and have uninterrupted views of the Zambezi.



Activities (on an inclusive rate) include a Victoria Falls Tour, sundowner cruises, tiger fishing, and visiting a nearby village. Others (extra cost) include white water rafting, bungee jumping, abseiling, canoeing, and flights over the Falls. The area is steeped in local history and rich in wildlife; hippo and elephant are seen regularly and birdlife is prolific.



FACILITIES & ACTIVITIES





TOKA LEYA CAMP

Wilderness Safaris - Classic Camp



Overlooking the Zambezi River and some of its islands is Toka Leya Camp, comprising 12 raised, spacious en-suite safari-style tents. Tent interiors boast wooden flooring, tasteful African décor, climate-control, and an expansive wooden deck from which to soak up the views. Family units are positioned to offer quiet seclusion.



The camp's dining and lounge areas offer ample space for relaxation. Meals are served on the sundeck, the pool deck and dining room all overlooking the Zambezi. There is a novel pizza oven and a curio shop. Activities (on fully inclusive rate) include a tour of the Victoria Falls on the Zambian side, game drives within Mosi-oa-Tunya National Park, river cruises, fishing and guided nature walks. Tours of Livingstone town and museum and visits to Mkuni Market and a nearby village add cultural diversity. Other activities on offer in the area at additional charge include sunset cruises, helicopter flights, microlighting, canoeing, jet boating, and white water rafting.



FACILITIES & ACTIVITIES





- AN INTRODUCTION TO -
ZIMBABWE



Two major rivers form the northern and southern boundaries of Zimbabwe: the great Zambezi River cuts along its northern frontier, while the languid Limpopo forms the southern border with South Africa. In between, the country has a variety of habitats, from the granite hills of the Matopos to the majestic mountains, lush forests and beautiful rivers of the Eastern Highlands. As such, there is much to attract the traveller, from wildlife viewing and adrenalin adventures to encountering the history of the Zimbabwean people going back thousands of years.

It is in the unspoilt and peaceful northern parks that we concentrate our safari operations. The Zambezi has an exceptional variety of spectacular scenery as well as one of the world's natural wonders: the Victoria Falls. Downriver, our concession lies in Mana Pools National Park, located on the floodplains of Africa's Great Rift Valley and offering superb wildlife viewing.

Along the Botswana border the easternmost tongues of the Kalahari sands creep into the country and mix with the teak forests of the interior, so that desert-adapted animals share the same habitat with woodland species. Hwange National Park is home to some of southern Africa's last great elephant, buffalo and sable herds. Wilderness' Makalolo and Linkwasha concessions within Hwange are truly wild areas which offer Zimbabwe's best summer game viewing.

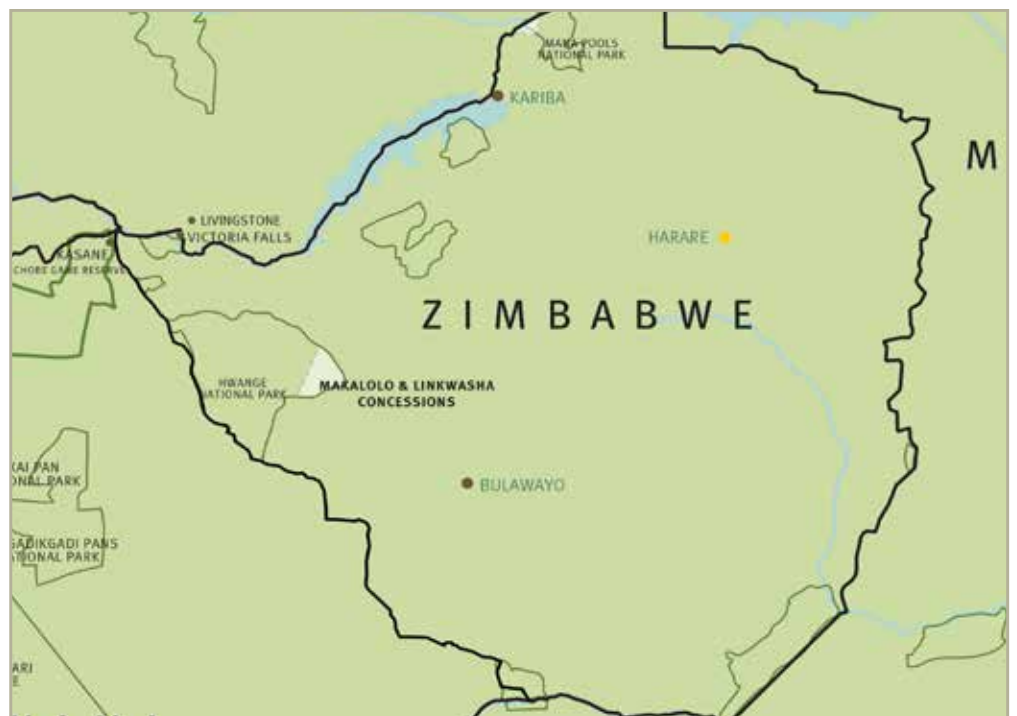

OUR ZIMBABWE AREAS

Hwange National Park

Hwange National Park is the largest game reserve in Zimbabwe. Situated on the easternmost edge of the Kalahari Desert, its 1.4 million hectares of sandy soils support extensive stands of broad-leafed woodland that during the summer months, despite the low rainfall, are a profusion of green. Along with salt pans, acacia scrub and grasslands the Park supports an enormous abundance of wildlife. Located on the border with Botswana, the Park was proclaimed some 70 years ago and has one of the densest concentrations of wildlife in Africa, in particular its herds of elephant and buffalo. There are a number of shallow pans spread throughout the Park, around which wildlife congregates, making for excellent game viewing. The private Makalolo and Linkwasha concessions, situated in its south-eastern corner, are ecologically diverse, including vast open palm-fringed plains, grasslands, acacia woodlands and teak forests. This ensures large numbers of animals all year round – elephant, buffalo, sable, roan, giraffe, wildebeest, impala and even gemsbok. These are followed by their predators: lion, leopard, wild dog and cheetah, along with African wildcat, serval, honey badger, civet and spotted hyaena. Of avian interest are species like Dickinson's Kestrel, Bradfield's Hornbill and Arnot's Chat.



Mana Pools National Park

Mana Pools National Park lies at the heart of the Zambezi Valley, where the Zambezi River meanders to the Mozambican border. It is a remote, beautiful place with spectacular views of the broad river, floodplains, riverine woodland and the mountains of the Rift Valley escarpment. This stretch of the Zambezi River is famous for its four main pools (after which the Park is named: 'mana' means 'four' in Shona) – Main, Chine, Long and Chisambuk – which are remnants of channels of the river which stopped flowing years ago. These and smaller seasonal pools dotted further inland hold water all year round, drawing all manner of wildlife and waterfowl during the dry season. The ana trees that characterise the floodplain shed their protein-rich pods during this time, providing vital sustenance for many species, particularly elephant. Wildlife viewing is excellent, with large concentrations of buffalo and elephant along the river's edges, while predators such as lion, wild dog and leopard are often sighted. Kudu, zebra, impala and waterbuck feed on the surrounding plains and the grunting of hippo can be heard all day. Birdlife is superb, particularly for both woodland and riverine species with numerous local specials such as Black-throated Wattle-Eye, Red-necked Falcon and Eastern Nicator.





LITTLE MAKALOLO CAMP

Wilderness Safaris - Classic Camp



Little Makalolo lies in one of Hwange National Park's best wildlife viewing areas. It offers privacy for guests who enjoy small camps and a sense of remoteness. The area is ecologically diverse, ensuring great numbers of animals year-round.



The camp's six spacious en-suite tents, with both indoor and outdoor showers, are nestled in the tree line, with solar power for hot water and lighting ensuring a lighter ecological footprint. A false mopane tree in the centre of the camp shades a separate dining and living area as well as a raised platform for views of the much-frequented waterhole. During siesta hours, guests can enjoy outstanding wildlife viewing at the log pile hide that overlooks the waterhole in front of camp. Activities centre on game drives in open 4x4 Land Rovers and guided walks. The area's large number of waterholes attracts game in both quantity and variety, especially in the winter months.



FACILITIES & ACTIVITIES





DAVISON'S CAMP

Wilderness Safaris - Adventures Camp



Nestled under a grove of ancient false mopane trees, Davison's Camp is situated in a remote north-eastern corner of Hwange National Park. Named after the founder of Hwange National Park and its first warden, Ted Davison, the camp overlooks an extremely productive waterhole that attracts a variety of plains game and predators. Eight twin-bedded tents and one family unit, along with a main area comprising a lounge and dining room, altogether offer the quintessential Hwange experience. a wonderful bush experience.

Game activities include game drives in open 4x4 vehicles, or guided walks in the early mornings and evenings, while during the siesta hours, guests can view game from their tent verandas, as thirsty wildlife comes down to the waterhole to drink.



FACILITIES & ACTIVITIES





RUCKOMECHI CAMP

Wilderness Safaris - Classic Camp



Ruckomechi Camp, situated on the western boundary of Mana Pools National Park, accommodates guests in ten spacious en-suite tented units, including a honeymoon suite, all of which overlook the wide Zambezi River. The camp is set amongst broad-canopied ana trees, much loved by the elephants for their rich nutritious seeds. Each tent has both indoor and outdoor showers, and the camp boasts a favourite amongst guests: its outdoor 'bath-with-a-view' in a secluded, scenic spot.



The central dining, bar, library and lounge areas face the escarpment and are connected to the rest of the camp by low-level walkways. There is a separate deck with an infinity pool and hammocks for swimming and sun bathing, and an inviting, cushion-strewn star gazing deck. Wildlife viewing takes place in open 4x4 vehicles, on motorised pontoon boats or on canoes, on foot and in hides.



FACILITIES & ACTIVITIES





Explorations are an innovative range of fully serviced, guided journeys that create an authentic sense of wild camping in Africa. These guided journeys utilise mostly private concessions and wildlife areas exclusive to Wilderness guests.

Explorations guides lead each journey from start to finish, creating a seamless and detailed interpretive experience. They are highly trained and noted for their passion and knowledge. Each Exploration uses different modes of transport depending on the environment and distances covered; however they also combine a number of the following: game drives, walks, mokoro rides, canoeing, boating and light aircraft transfers, enhancing the experience.

Each itinerary has been carefully created with the seasons, game movements and guest experience in mind. All itineraries have set departure dates, and operate with minimum 2 and maximum 8 confirmed guests per safari. Personally crafted Explorations are available on flexible dates and itineraries can be tailored for private groups or families (4-8 guests).

There are three styles of Explorations, all of which recreate that atmosphere of an unhurried journey through Africa. Finally, there are a number of different accommodation styles, including our own unique Discoverer, Adventurer and Trails camps.



Discoverer Explorations

Discoverer Explorations are fully serviced deluxe guided journeys, with accommodation alternating between Discoverer Camps – private camps set in secluded locations – and Wilderness camps, all with superb views. Discoverer Camps are permanent wood and canvas tents with en-suite bathrooms and a comfortable lounge, dining and outdoor boma area.



Adventurer Explorations

Adventurer Explorations camps are pitched for the season, mostly in private concessions in prime, shady and scenic sites. The camps comprise either dome tents or mini-Meru tents, with en-suite hot bucket showers and toilet facilities. Hammocks and safari camper chairs are ideal for midday siestas, while dining under the stars and around the fire create an authentic safari experience. Thanks to the camps' mobility, these Explorations explore the most remote and secret seasonal highlights of the subcontinent.



Trails Explorations

This type of Exploration is the most active and offers the lowest carbon footprint, defined mainly by its unique mode of transport – be it on foot or by canoe. Trails Camps are mobile camps – dome tents complete with en-suite bathrooms and bucket showers – that allow access to very remote locations.



THE GREAT WILDERNESS JOURNEY

A Discoverer Exploration - Ten nights/Eleven Days



This Classic Camp and deluxe camping safari takes the time to experience and explore Botswana’s scenic northern areas: from the lushly vegetated wetlands of the Okavango Delta to the game-rich floodplains of Linyanti and Chobe, finally ending with the world-famous Victoria Falls on the Zambian side. Three-night stays in each area in Botswana ensures detailed insights into habitats and game movements in the area, and there is a wide range of activities: walks, day and night wildlife viewing – both water- and land-based. Private wilderness areas within Okavango Delta and Linyanti are visited.

BRIEF ITINERARY:

- Day 1:** Arrive in Livingstone, guided tour of Victoria Falls; drive to The River Club or Toka Leya Camp, Livingstone
- Days 2, 3 & 4:** Fly to Kasane for a river boat cruise in the Chobe National Park; fly to Linyanti Discoverer Camp, Linyanti Concession
- Days 5, 6 & 7:** Fly to Khwai Discoverer Camp, Khwai Concession, north-eastern Okavango Delta
- Days 8, 9 & 10:** Fly to Jacana Camp or Xigera Camp, Okavango Delta
- Day 11:** Fly to Maun Airport



FACILITIES & ACTIVITIES



Discoverer



Khwai, Linyanti, Jacana, Toka Leya, Xigera



Khwai, Linyanti, Jacana



Jacana, Xigera



Chobe



Khwai, Toka Leya, Jacana, Linyanti



Jacana, Xigera



Khwai, Linyanti, Jacana, Toka Leya, Xigera





MIGRATION ROUTES

An Adventurer Exploration - Nine nights/Ten days



This short nature- and wildlife-focused route explores the thundering waters of the Victoria Falls, the continually moving wildlife of northern Botswana within the broad vistas of the Linyanti with its wooded deciduous forests and the crystal-clear waterways and fertile green islands of the Okavango Delta. Staying in private wilderness areas and with a diverse range of activities, we follow the fault lines of northern Botswana, covering these unique and wild areas from the air, by vehicle, on foot and in mokoro, ensuring a close connection with nature and spectacular game viewing.

BRIEF ITINERARY:

Day 1: Arrive in Livingstone, guided tour of Victoria Falls; drive to The River Club or Toka Leya Camp, Livingstone

Days 2, 3 & 4: Road transfer to Kasane for a river boat cruise in the Chobe National Park; fly to Linyanti Adventurer Camp, Linyanti Concession

Days 5, 6 & 7: Fly to Khwai Adventurer Camp, Khwai Concession, north-eastern Okavango Delta

Days 8 & 9: Fly to Xigera Mokoro Trails, Moremi Game Reserve, Okavango Delta

Day 10: Fly to Maun Airport



FACILITIES & ACTIVITIES



Adventurer



Linyanti, Khwai



Linyanti, Khwai



Xigera Mokoro Trails



Chobe River



Livingstone, Linyanti, Khwai, Xigera



Linyanti, Khwai, Xigera



BOTSWANA SUMMER ENCOUNTER

A Discoverer Exploration – Nine nights / Ten days

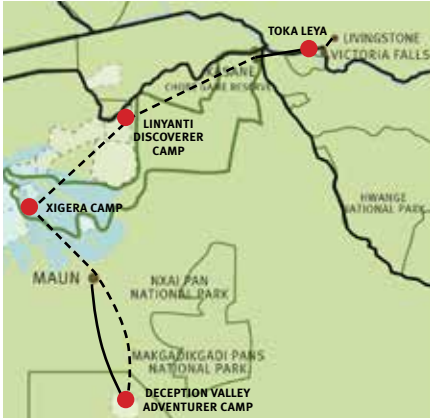

This Exploration reveals the life-filled summer season of Botswana, in prime areas where few people travel. Beginning at the “petrified” river valley of Deception Valley in the Central Kalahari Game Reserve, the sporadic summer rains cause wildlife to migrate into the desert valleys in large numbers. The always fertile green islands of the Okavango and its crystal-clear waterways are one of the most fascinating ecosystems on the planet while the diverse and wildlife-rich Linyanti and Chobe River systems is an essential compliment to Delta. The journey ends appropriately at the world-famous Victoria Falls on the Zambian side of the Zambezi River.

BRIEF ITINERARY:

Days 1, 2 & 3: Arrive in Maun and fly to Central Kalahari Game Reserve, then game drive to Deception Valley Trails Camp

Days 4 & 5: Overland to Maun (approx. 6 hours) and then fly to Xigera Camp, Okavango Delta

Days 6, 7 & 8: Fly to Linyanti Discoverer Camp, Linyanti Concession

Day 9: Fly to Kasane for Chobe River boat cruise; then road transfer to Toka Leya, Livingstone

Day 9: Guided tour of Victoria Falls; road transfer to Livingstone Airport

Please note: This Exploration only runs between December and February.



FACILITIES & ACTIVITIES

 Adventurer	 Central Kalahari, Xigera, Linyanti, Toka Leya	 Linyanti	 Xigera
 Central Kalahari	 Chobe River	 Livingstone, Linyanti	 Central Kalahari, Xigera, Linyanti, Toka Leya





GREEN DESERT EXPEDITION

An Adventurer Exploration - Six nights/Seven days



This magnificent Exploration contrasts the sporadic rains of the Kalahari Desert with the always-fertile islands and waterways of the Okavango. It takes place during the Kalahari's most productive season, when it receives low rains and wildlife migrates in large numbers into the desert valleys. This precious water creates a short yet incredibly prolific wildlife-viewing period with concentrations of desert species and their young in the ancient river valleys of Deception Valley. An all-day game drive (or two) in the reserve adds immeasurably to the sightings of this abundance. Then, in a stunning contrast, the vibrant water wonderland of Xigera in the Okavango Delta is explored.

BRIEF ITINERARY:

Days 1: Drive to Deception Valley Lodge, Kalahari, just north of Central Kalahari Game Reserve

Days 2, 3 & 4: Drive to camp in Deception Valley, Central Kalahari Game Reserve

Days 5 & 6: Transfer by road to Maun and fly to Xigera Camp, Okavango Delta

Days 7: Fly to Maun Airport



Please note: : This Exploration only takes place between December and May. Highly recommended: The addition of a Linyanti and/or a Livingstone camp after Xigera, as it rounds off the impressions and diversity of the country.



FACILITIES & ACTIVITIES



Adventurer



Deception Valley Lodge,
Central Kalahari



Deception Valley Lodge



Deception Valley Lodge,
Central Kalahari



Xigera



Xigera,
Deception Valley Lodge



Xigera

SELINDA CANOE TRAIL

A Trails Exploration - Three nights/Four days



This canoeing and walking adventure safari navigates some 45km (25 miles) along the Selinda Spillway in the heart of Botswana's Selinda Reserve. Days are spent paddling eastwards in 5.5 metre (18-foot), stable Canadian-style canoes with cushioned seats, along the Spillway, viewing wildlife and bird species that may be seen along the banks. The area is well known for elephant, buffalo, sable antelope, roan antelope and wild dog, as well as some 300 bird species. Cheetah, lion and leopard are occasionally seen. The area evokes remoteness and solitude.

BRIEF ITINERARY:

Days 1, 2 & 3: Game drive transfer from Selinda airstrip to starting point on the spillway, paddling downstream, overnighting in true wilderness areas for three nights

Day 4: Transfer by road to Selinda airstrip for onward arrangements

Please note: This Exploration only runs between May and October.

Highly recommended: A night spent at Selinda or Zarafa camps before or after the Trail.



FACILITIES & ACTIVITIES





THE GREAT NAMIBIAN JOURNEY

A Discoverer Exploration – Eleven nights / Twelve days



This quintessential journey encompasses Namibia’s attractions as a whole: stunning landscapes, endless skies, barren deserts, rugged mountains and spectacular wildlife. Explore the dunes of Sossusvlei and the awesome space of the Namib Desert. Encounter the stark beauty and diversity of the Kunene region, marine life around Swakopmund and the game-filled savannahs of Etosha. Such experiences are enhanced by a range of lodges, including diverse activities such as a dolphin cruise with private beach lunch at Walvis Bay, hiking in Damaraland, interacting with the Damara people (dependent on their movements) and tracking black rhino on foot, along with optional hot air ballooning and horse-riding (additional cost).

BRIEF ITINERARY:

Days 1 & 2: Drive from Windhoek to Kulala Desert Lodge, Sossusvlei

Days 3 & 4: Scenic flight to Swakopmund, to stay at Hansa Hotel

Days 5 & 6: Transfer by road via Cape Cross Seal Colony to Damaraland Camp, Damaraland

Days 7 & 8: Drive to Desert Rhino Camp, Palmwag Concession

Days 9, 10 & 11: Transfer by road to Ongava Tented Camp, Etosha National Park

Day 12: Fly to Windhoek



Highly recommended: Visit Serra Cafema after Ongava Tented Camp (additional cost).



FACILITIES & ACTIVITIES



Discoverer



Kulala, Damaraland, Ongava



Kulala, Damaraland, Ongava, Desert Rhino Camp



Kulala, Damaraland, Ongava, Desert Rhino Camp



Desert Rhino Camp



Kulala, Swakopmund, Damaraland, Ongava



Twyfelfontein



Sandwich Harbour and Walvis Bay



Ongava



Walvis Bay



DIVERSE NAMIBIA

An Adventurer Exploration - Nine nights/Ten days



Diverse Namibia is an active, exciting adventure, exploring key areas of this vast country – its dunes, desert, plains and iconic wildlife – complete with exclusive accommodation in exclusive reserves and concessions and private access to Sossusvlei. Diverse Namibia takes in the soaring red dunes of Sossusvlei, the life-filled blue Atlantic Ocean, the desert and denizens of Damaraland, and the plains game and predators of Etosha National Park. Throughout the Exploration are interspersed activities such as scenic walks, visiting the spectacular and ancient rock engravings at Twyfelfontein and rhino tracking, along with optional hot air ballooning and horse-riding (additional cost) – overall a true Namibian adventure!



BRIEF ITINERARY:

- Days 1 & 2:** Drive from Windhoek to Kulala Adventurer Camp, Sossusvlei
- Days 3 & 4:** Transfer by road to Hansa Hotel, Swakopmund
- Days 5, 6 & 7:** Drive via Cape Cross seal colony to Damaraland Adventurer Camp, Damaraland
- Days 8 & 9:** Road transfer to Andersson's Camp, Ongava Game Reserve, Etosha region
- Day 10:** Drive to Windhoek



FACILITIES & ACTIVITIES



Adventurer



Kulala, Damaraland, Andersson's



Kulala, Damaraland, Andersson's



Kulala, Damaraland, Andersson's, Swakopmund



Damaraland



Kulala, Damaraland, Andersson's



Walvis Bay



Walvis Bay



Damaraland





RIFT VALLEY EXPLORER

A Discoverer Exploration – Nine nights / Ten days

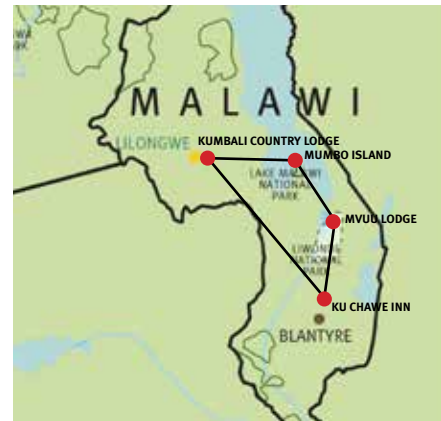

This Exploration, with its constant contrast and variety, covers about 800 kilometres and three of southern Malawi’s most fascinating destinations – all relatively close together and encompassing different types of wilderness, culture, and wildlife. Exploring the mountainous spaces of Zomba Plateau is followed by viewing the wildlife of Liwonde National Park on foot, by boat and vehicle. The Exploration ends with three days of relaxation (with various activities for the more energetic!) on the beautiful eco-friendly Mumbo Island. The drives between the destinations are a revelation, providing ample opportunities to meet the friendliest people in Africa.

BRIEF ITINERARY:

- Day 1:** Drive from Lilongwe Airport to Kumbali Country Lodge, Lilongwe
- Days 2 & 3:** Drive to Ku Chawe Inn, Zomba Plateau
- Days 4, 5 & 6:** Continue by road to Mvuu Lodge, Liwonde National Park
- Days 7, 8 & 9:** Drive to Chembe Village and either kayak or transfer by boat to Mumbo Island, Lake Malawi National Park
- Day 10:** Return to Lilongwe by road



Please note: This Exploration operates between May and November.



FACILITIES & ACTIVITIES



Discoverer



Mvuu Lodge



Mvuu Lodge



Ku Chawe Inn, Mvuu Lodge, Mumbo Island



Mvuu Lodge



Mumbo Island



Mumbo Island



Mumbo Island



LANDSCAPES OF MALAWI

An Adventurer Exploration – Seven nights / Eight days

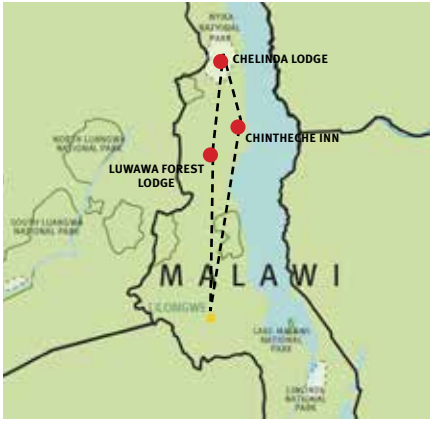

This Exploration combines some of the most unspoilt parts of the country with authentic cultural experiences amongst its people. From the rolling hills, river valleys and granite outcrops of the Viphya Mountains to the unique Nyika National Park with its cool climate, diverse habitats and spectacular vistas – a scene seemingly more fitting to Europe than Africa – to end on the central shores of Lake Malawi that reveal a blend of stunning beaches, vibrant local communities and exceptional freshwater fishlife. Each night is spent in fully serviced camps that allow a sublime “back to nature” experience. The road transfer between each destination showcases the breathtaking landscapes and colourful cultures of Malawi.









BRIEF ITINERARY:

- Day 1:** Drive from Lilongwe to Luwawa Forest Lodge, Luwawa Forest Reserve
- Days 2, 3 & 4:** Transfer by road to Chelinda Lodge, Nyika National Park
- Days 5, 6 & 7:** Drive to Chintheche Inn, Northern Lakeshore
- Day 8:** Return to Lilongwe by road

Please note: This Exploration operates between May and November.



FACILITIES & ACTIVITIES

 Adventurer	 Chelinda Lodge	 Chelinda Lodge	 Chintheche Inn	 Chintheche Inn
 Chintheche Inn	 Chintheche Inn	 Chintheche Inn	 Chintheche Inn	





PAFURI WALKING TRAIL

A Trails Exploration - Three Nights/ Four Days

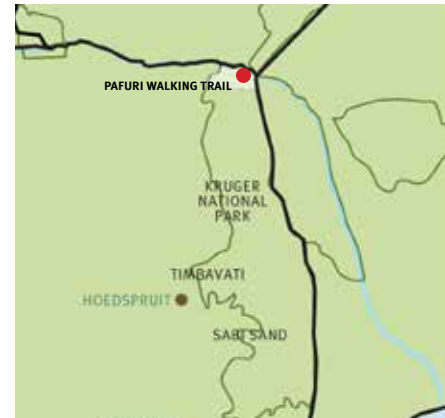

Regarded as the best walking area in the Kruger National Park, the Makuleke Concession, or Pafuri, is blessed with exceptional biodiversity and scenery. Using the camp site as a base, each day is spent in different parts of the surrounding area, walking along pathways made over the years by its animal inhabitants. Access to sites of phenomenal scenic and historical value as well as abundant game, spectacular scenery, a sense of history and a true feeling of wilderness characterises this Exploration. Wildlife includes nyala, buffalo herds, and seasonal elephant; more elusive residents of the area are white rhino, lion and leopard. For the keen birder, the Pafuri Walking Trail is a must.

BRIEF ITINERARY

Day 1: Arrive at Pafuri Camp to check in and meet your guide before driving to the first camp site. Enjoy a short walk before sundowners and campfire dinner at the Trails Camp.

Days 2 & 3: Walk approximately three to four hours in the morning; relax during the heat of the day, then walk about one-and-a-half hours in the afternoon. Overnight at the Trails Camp.

Day 4: Following an early morning walk and final brunch, return to Pafuri Camp.

Please note: Pafuri Walking Trails departs every Monday and Friday between 1 April and 31 October.



FACILITIES & ACTIVITIES



Trails Exploration



Pafuri



Pafuri

MANA CANOE TRAIL

A Trails Exploration - Three nights/Four Days



This safari is perfect for adventurous travellers, allowing close encounters with wildlife on one of the greatest rivers in Africa. This thrilling experience traverses the Mana Pools National Park, along the Zambezi River, canoeing in comfortable, stable Canadian canoes past more than a thousand hippo on the way! Each night is spent camping on the banks of the Zambezi, finishing 65km (40 miles) and many adventures downstream. Encounters with animals and birds, whether on canoe or on foot, are up close and awe-inspiring. The Trail, for reasonably fit guests, is led by an experienced guide and assisted by support vehicles and staff.

BRIEF ITINERARY:

Day 1: Arrival at Ruckomechi, safety briefing and short canoe excursion to first camp, Mana Pools National Park

Day 2 & 3: Full days canoeing and walking through wilderness zone of Mana Pools

Day 4: End canoeing and transfer to Chikwenya airstrip

Please note: This Exploration operates between May and November.
Highly recommended: Enjoy additional nights at Ruckomechi Camp before or after the safari (additional cost).



FACILITIES & ACTIVITIES



Connecting You To The Wilderness



Wilderness Air aims to provide a safe, efficient and reliable service to passengers. We operate a varied fleet of light aircraft, chosen for their ability to transport visitors to remote wilderness destinations with short, dirt-surfaced landing strips.

All these aircraft types differ in their characteristics and are uniquely suited to different types of journey, varying group sizes, and clients with different personal needs. The majority of our fleet operate on a scheduled route basis; however we also offer charter flights for tailor-made journeys.

Maintaining its safety record throughout, the company began operating in 1991 with one aircraft based in Botswana servicing two camps in the Delta. Today Wilderness Air is also based in Namibia, Zambia, Zimbabwe and the Congo and operates some 40 aircraft.

Wilderness Air is privileged to fly into some of the most pristine wilderness destinations in the world. We believe flying is an integral part of a guest's holiday experience and therefore our pilots need to have a fundamental enthusiasm for being in such areas.

With this notion, Wilderness Air is proud to be the air support of Wilderness Safaris, a responsible ecotourism and conservation company with private access to some of southern Africa's finest wildlife areas. It is through these wilderness areas that we are able offer our guests a unique and life-changing experience.



STANDARDS AND PRINCIPLES

The service offered by Wilderness Air is more than a simple connection. The aerial transfers between camps provide a totally different impression and appreciation of the country below. First and foremost, however, there are five critical objectives to which we subscribe.

Safety

Safety is our primary concern and therefore we continually examine and assess safety requirements within our business process. Over the years, the company has kept abreast of the latest safety standards and has tested and implemented them. This approach has put us at the forefront of the niche in which we operate.

Insurance

Wilderness Air has comprehensive liability insurance, which does not have a per seat limit, but rather a per aircraft limit:

Caravan (C208): US\$20 million

C210 and C206: US\$7.5 million

Insurance Cover – Aviation Passenger Liability General Details:

Type of Insurance: Aviation Passenger Liability • Insurers: Lloyd's of London/Santam Insurance Company • Insured: Wilderness Air Charters and/or Subsidiary and/or Associated Companies • Period of Cover: From 01 March 2013 to 28 February 2014 (both days inclusive) • Jurisdiction: Worldwide • Territorial Limits: Sub-Saharan Africa

Training

In addition to their previous training, our pilots are all put through a strenuous 100-hour training programme before they fly guests on their own. Wilderness Air pilots are almost all trained in Botswana and Namibia when they join Wilderness Air. This means that all our pilots are adequately prepared for the specific conditions that flying into the unique wildlife areas of southern Africa demand. Finally, pilots must pass a proficiency check every six months.

Service (Northern Air Maintenance)

Wilderness Safaris as a group uses selected Civil Aviation Authority (CAA) approved maintenance organisations in each country. Aircraft in the Wilderness Air Botswana, Wilderness Air Zambia and Wilderness Air Zimbabwe fleets are maintained by Northern Air Maintenance (NAM) of which Wilderness Safaris is the parent company. Aircraft are maintained according to regulated maintenance schedules as stipulated by the relevant CAAs and also in accordance to manufacturer requirements. Northern Air Maintenance is recognised as the foremost provider of this service in Botswana and included amongst its clientele are most air charter operations based in Maun.

Quality

Over and above ad-hoc external audits, each Wilderness Air operation and its Aircraft Maintenance Organisation (AMO) are audited annually by the CAA in the relevant country of operation. In all audits to date we have been found to be compliant with all local and international maintenance control standards.

SAFETY MANAGEMENT

Safety is the number one priority for Wilderness Air. To that end we employ a highly experienced Group Safety Officer to oversee the safety management of our business. In aviation, safety management has some key guidelines, the heart of which is to ensure that a just culture prevails in our business and that our staff feel free to report on any safety-related issues or concerns. Our Group Safety Officer has vast aviation experience and has the stature to command the respect of our management at Wilderness, the Risk Committee section of our board, as well as our pilots on the front line, all with the sole purpose of keeping our business safe.

In each region, a trained designated Safety Officer with the necessary safety qualifications (required by the relevant Civil Aviation Authorities) reports to the Group Safety Officer. This safety monitoring is done in accordance with ICAO (International Civil Aviation Organisation) standards. The Safety Management System (SMS) we use is web based and ensures that all safety reports get from the front line of our business to our safety officers promptly. Using this information we are able to take prompt corrective action when necessary.

Single Engine Aircraft Safety

The aircraft in our fleet are specifically chosen for their suitability to the type of airstrips that are found in the remote locations in which we operate. The single turbine engine of the Cessna Grand Caravan C208B, which constitutes a large portion of our fleet, has been proven to have an excellent safety record. The caravan is powered by a Pratt and Whitney Pt6A engine – which has a record as one of the most reliable engines ever built. We take our maintenance seriously and we only ever use factory-approved engine maintenance facilities.

Airstrip Investment

Over the years, Wilderness Safaris has taken great pride in the upkeep of airstrips that are safe and adequate for our operations. We pay careful attention to runway width, length and ample clear area on either side as well as at each end of our airstrips. In addition, airstrips are checked daily prior to each take-off and landing.

Animals on our Airstrips

Guests visit the pristine locations we operate in to see, among other things, wild animals. We share our bush airstrips with those animals and therefore, it is important that for every aircraft arrival and departure we have processes in place to ensure that the risk of colliding with those animals is reduced. Our guides and our pilots are specifically trained to follow processes to manage these risks as carefully as possible.

Satellite Tracking System

The majority of our aircraft are fitted with a real-time satellite tracking system. With this system, our operational bases get a constant update of each aircraft's position, airspeed and altitude. Apart from the obvious safety benefit, it also means that our operations staff are able to keep camps accurately updated as to arrival and departure times. It is our plan to fit all our aircraft with this system in the near future.

Engine Condition Trend Monitoring System

Most of our Cessna Grand Caravan C208B fleet is fitted with an engine trend monitoring system, which allows the maintenance organisation to monitor engine performance of individual aircraft. This system will detect any abnormal shifts in engine performance, and provides us with diagnostic information to timeously attend to maintenance issues before they become a concern.

SAFETY MANAGEMENT

Luggage, Weight and Safety

Our aircraft are not airliners – relatively speaking, they are small. This means that we have small baggage stowage bays and restrictive weight limitations, both for luggage and passengers. The Wilderness Air luggage specifications are as follows:

- Soft (all sides) luggage / duffel bags – with no rigid sides or wheels.
- Maximum luggage weight is 20kg (44lbs), including all carry-on luggage if more than one bag and camera equipment.
- Maximum luggage size is 25cm (10 inches) wide x 30cm (12 inches) high x 62cm (24 inches) long.
- If guests weigh more than 100kg (220lb), additional weight allowance on the aircraft must be purchased for safety and comfort. The cost is calculated on request according to the specific region and routing.



OUR AIRCRAFT

The Cessna Aircraft Company in Kansas, USA, has a legacy of aircraft production spanning almost a century, manufacturing the most comprehensive line of light aircraft in the world. Wilderness Air operates a selection of these aircraft.

The Cessna Grand 208B Caravan was designed at the outset to be simple, rugged and reliable. This aircraft has proven to be an outstanding passenger-carrying bush aircraft for journeys from 20 to 300 kilometres, while still being comfortable enough for trips of up to 1 000 kilometres. The Caravan is capable of taking off from nearly all the bush airstrips we service, made possible by its large wheels, a highly efficient wing design and powerful engine. Its wide, spacious, air-conditioned cabin, large windows and unrestricted view make the Caravan a very popular choice with passengers. The 4-door cargo pod located under the fuselage also provides generous luggage carrying capacity.

Wilderness Air operates the C210 mainly in Namibia and Zambia, as the longer sector distances in these two countries necessitate a faster aircraft. Unlike the C206, the C210 does not have a cargo pod, so it has a slightly smaller luggage capacity than the C206. The unobstructed view offered by the high-wing configuration allows all passengers the best possible aerial vistas.

Wilderness Air uses the C206 mainly in the Okavango Delta, Botswana, as it is well suited to the shorter hops between the various Okavango Delta camps. The C206 has earned the reputation of 'workhorse of the Delta' and performs inter-camp transfers effortlessly. It is also used for delivering all important supplies to the remote, inaccessible safari camps for which Wilderness is renowned.



Cessna C206

Cessna C210



Cessna Grand Caravan 208B



Cessna Grand Caravan 208B

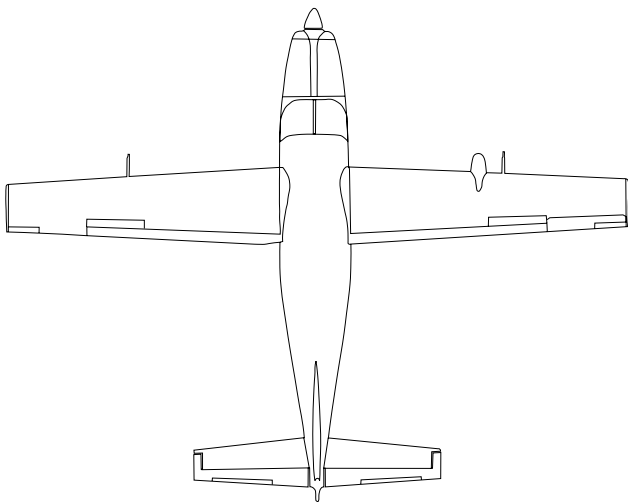

Maximum passengers — 12

Specifications

- Engine Type: 1 Turboprop Engine, PT6A-114A
- Pressurised Cabin: No
- Operating Altitude: 3 600ft – 11 500ft
- Demurrage: 650km/day
- Speed: 280km/h (150 Knots)
- Crew: 2
- Performance: Operates at a maximum altitude of 12 000 feet when carrying passengers. Typically on a 30-minute sector the plane will be flown at 6 500 feet.

CABIN SIDE VIEW

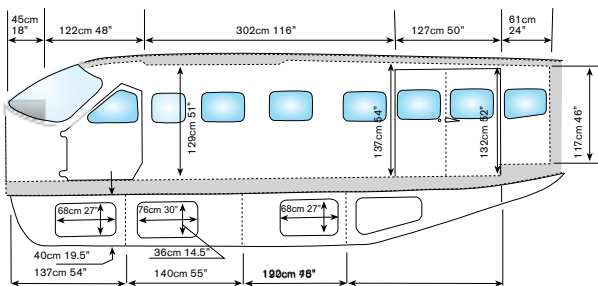

CABIN PLAN VIEW

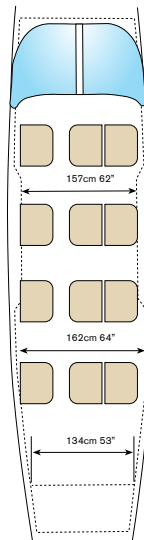

CARGO POD PLAN VIEW

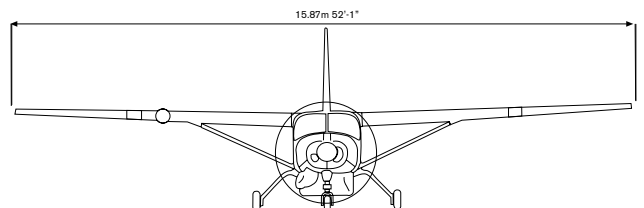
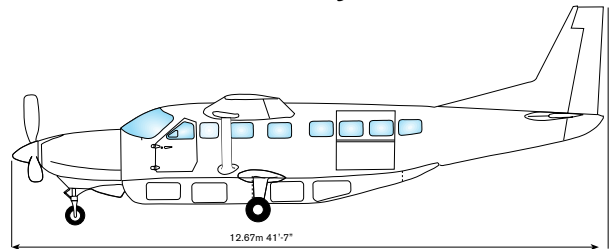
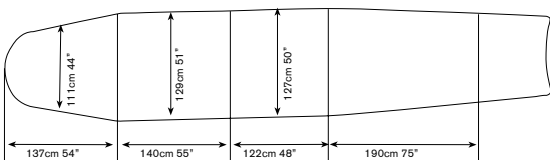

Cessna C206



Maximum Passengers – 5

Specifications

Engine Type:	Single Piston Engine
Pressurised Cabin:	No
Cruising Altitude:	3 600ft – 11 500ft
Demurrage:	500km/day
Speed:	220km/h (120 Knots)
Crew:	1
Performance:	A service ceiling 12 000 feet. Maximum take-off weight is 3 600lbs.

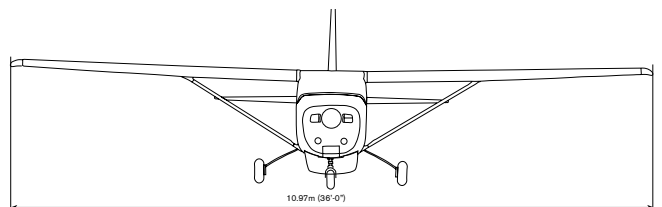
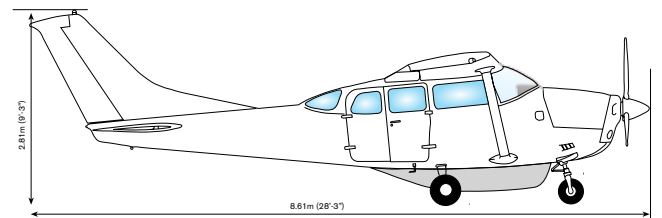
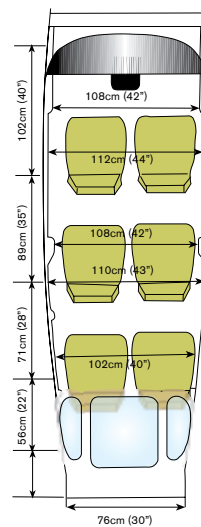
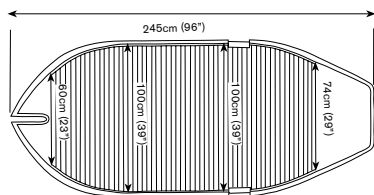
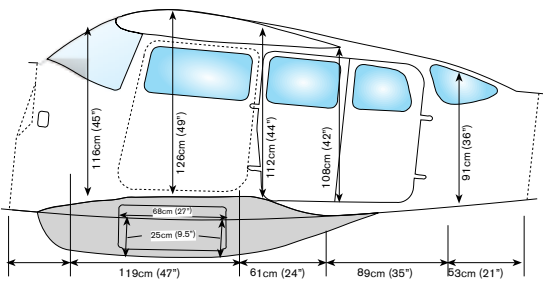
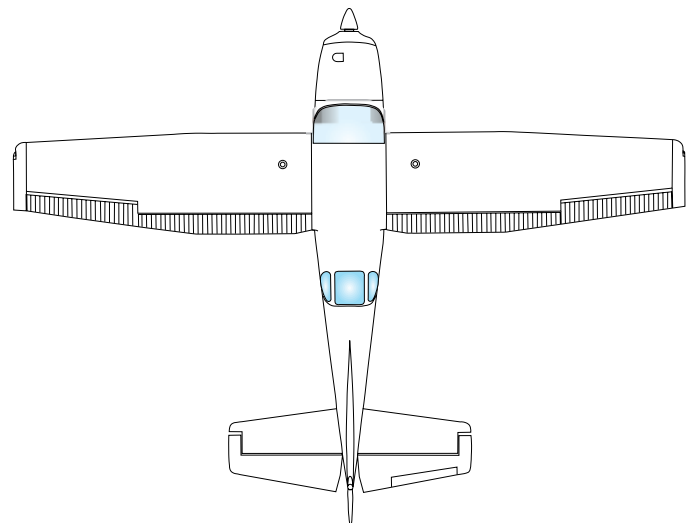

Cessna C210

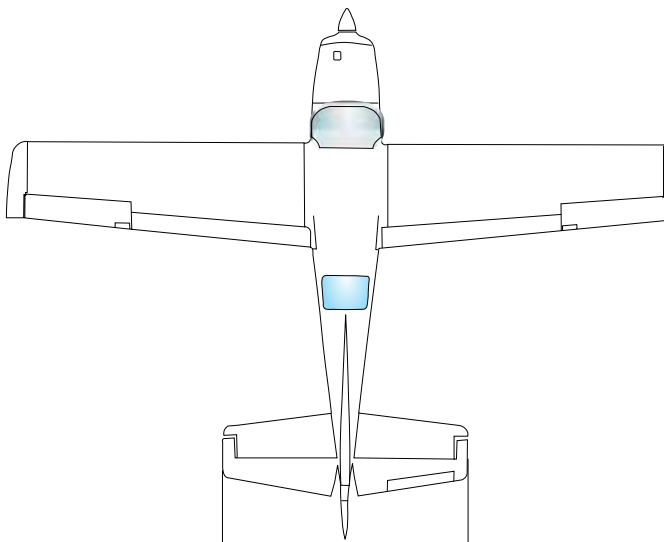

Maximum passengers — 5

Specifications

Engine Type:	Single engine piston
Pressurised Cabin:	No
Cruising Altitude:	12 000ft
Demurrage:	500km/day
Speed:	250km/h (135 Knots)
Crew:	1
Performance:	A service ceiling of 12 000 feet. Maximum range with reserves is 1 972km (1065nm).

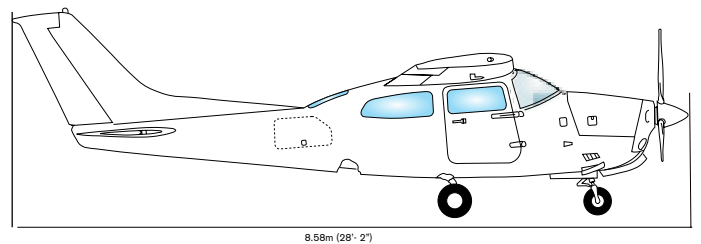
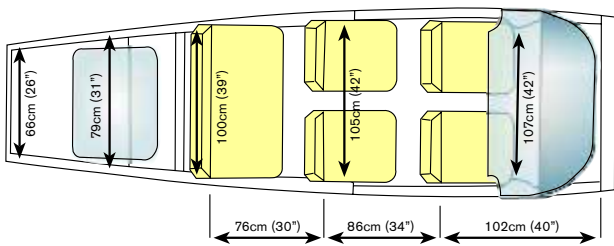

8.58m (28' 2")

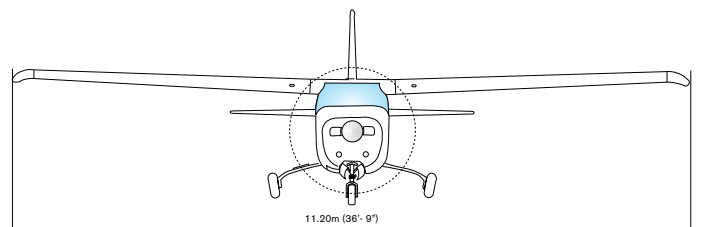
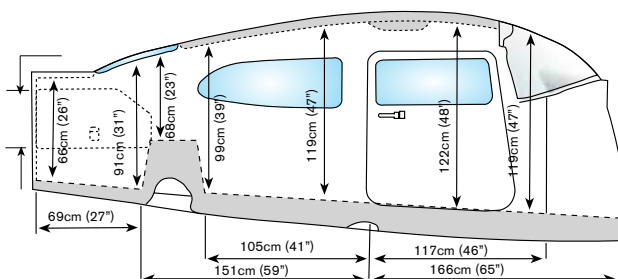

11.20m (36' 9")



Tailor-made day and overland tours of Cape Town, Windhoek and Victoria Falls

Wilderness Touring is a specialist partner of Wilderness Safaris, coordinating all aspects of a touring experience, including meet-and-greets, transfers, and tailor-made touring itineraries. This includes a wide range of full- and half-day excursion options for guests ranging from Scheduled Group Tours to Fully Inclusive Private Touring.

Our hand-picked team of consultants have a wealth of experience that we place at your disposal to ensure a perfect, unique itinerary. Our guides have all been chosen for their special knowledge, their personable dispositions and their ability to share their knowledge in a way that will inspire interest. Their special fields cover a wide range of interests from Archaeology to Zoology and everything in between.

Wilderness Touring incorporates the Wilderness Safaris Tours and Transfers companies in Cape Town (South Africa), Windhoek (Namibia), Victoria Falls (Zimbabwe), and Livingstone (Zambia):

Cape Town: Wilderness Touring Cape has been an expert in bespoke itineraries to the Western and Northern Cape, and the magical Garden Route regions of South Africa for 15 years. Its home base, Cape Town, is regarded as the gateway to Africa, offering visitors an ideal starting or end point to their African safari. The strength of this boutique operation is that it provides highly personalised service while offering competitive rates, coupled with many years of travel expertise and most importantly, passion.

There are fantastic activities that are available in conjunction with our standard **Peninsula Tour**, packing even more adventure into the day. Add one of the below to enhance your journey:

- Great White Shark Safari
- Travel in a Water Taxi
- Whale Watching Boat Trip
- Surfing and Muizenburg Beach
- Kayaking to Penguin Colony
- Peninsular by Helicopter





Namibia: In and around the two major centres of Windhoek and Swakopmund, our professional transfer operations provide a vital, informative round-the-clock link to our safaris, using our late-model fleet and trained driver-guides. Sole use of private vehicle and guide can be requested. Our township tours provide wonderful insights into the dynamic of the nation. As these are perfectly safe and highly recommended, guests should try to schedule a full day in Windhoek for them.

Zambia and Zimbabwe: Wilderness Touring Zimbabwe has an office in Victoria Falls, a tours desk at The Victoria Falls Hotel, and operates a fleet of vehicles from its premises. There is so much to do in and around Victoria Falls and professional staff both in the town and across the border in Livingstone, at The River Club and at Toka Leya camps assists guests in planning exciting and varied itineraries, from bungee jumping to elephant safaris, from sunset cruises to cultural tours, and much more. Wilderness Touring staff regularly call on guests at their hotels so as to be of assistance.





WILDERNESS SAFARIS PARTNER PRODUCT

Wilderness Safaris Partner Product is an extension of Wilderness Safaris, where the Wilderness experience is supplemented by a comprehensive range of Partner Products: an extensive portfolio of third party products, meticulously selected and featuring exceptionally competitive pricing. We facilitate journeys together with the Wilderness Safaris products to offer complete, tailor-made journey services for individuals and groups throughout southern Africa.

Partner Product services include:

- Tailor-made and personally designed FITs, family holidays and honeymoons
- Self-drive adventures
- Bespoke fly-in journeys
- Specialised groups and incentives
- Luxury rail experiences

Places and areas within the portfolio include – but are not limited to:

- The southernmost point of Africa – Cape Town and its iconic Table Mountain, the beaches, the Winelands area, historical landmarks, and the staggeringly scenic Fynbos Plant Kingdom.
- The dramatically beautiful southern shoreline of the Garden Route.
- The two-million hectare Kruger National Park, South Africa's largest conservation area and the private lodges of the Sabi Sand Game Reserve.
- The roaring curtain of water that is Victoria Falls, straddling Zimbabwe and Zambia.
- The warm waters and idyllic beaches of the Indian Ocean, including Mozambique.



MORE THAN JUST A SAFARI

At Wilderness Safaris, our delight is to share the wild places of Africa with our guests, while our ultimate goal is to help make a difference to Africa, its people and its wildlife. As a guest, you are helping us to do so.

There is much more that needs to be done, however, which is why, some 20 years ago, we created the **Wilderness Safaris Wildlife Trust**, an independent entity that supports a wide variety of wildlife management, research and education projects throughout Africa. These projects address the needs of our wildlife, seek solutions to save threatened species and provide education and training for local communities. This has made our journey more meaningful and we've reached more people and places than before.

Conservation of animals and plants is only as strong as the people who live in their vicinity. If they're not interested, protection is likely to exist only on paper. That's why Africa's future lies in her children, and why our pride and joy is our **Children in the Wilderness programme**, which aims to educate the youth of Africa, inspiring and helping them to appreciate and thus protect their magnificent natural heritage.

Every year, we close some of our camps for a week at a time and groups of 16 to 25 children between the ages of 10 and 14 are hosted here, given the opportunity to experience these wilderness areas and their wildlife. During camp, the curriculum covers environmental education, HIV/ AIDS and nutrition and life skills, and the importance of conservation. No less importantly, throughout the year, Eco Clubs are held at the local schools (i.e. schools situated near Wilderness Safaris areas), where we can visit the children in their own environment, providing opportunities for all learners who are interested in the environment to meet, learn, discuss and expand their knowledge of their natural heritage.

Our guests can be proud to be part of this life-changing journey.





INDEX

CAMPS

Abu Camp	30
Andersson's Camp	72
Banoka Bush Camp	35
Busanga Bush Camp	85
Chelinda Camp	57
Chelinda Lodge	56
Chintheche Inn	55
Chitabe Camp	33
Chitabe Lediba	34
Damaraland Camp	64
Davison's Camp	93
Desert Rhino Camp	66
Doro Nawas Camp	65
Duba Plains	24
DumaTau Camp	37
Hoanib Skeleton Coast	67
Jacana Camp	26
Jao Camp	25
Kalahari Plains Camp	41
Kalamu Lagoon Camp	86
Kings Pool	36
Kulala Desert Lodge	63
Kwetsani Camp	27
Lango Camp	44
Little Kulala	62
Little Makalolo Camp	92
Little Mombo	21
Little Ongava	69
Little Tubu	29
Little Vumbura	23
Mombo Camp	20
Mumbo Island Camp	54
Mvuu Camp	53
Mvuu Lodge	52
Ngaga Camp	45
North Island	76
Ongava Lodge	71
Ongava Tented Camp	70
Pafuri Camp	80
Rocktail Beach Camp	81
Ruckomechi Camp	94
Savuti Camp	38
Seba Camp	31
Segera Retreat	48
Selinda Camp	40
Serra Cafema Camp	68
Shumba Camp	84
The River Club	87
Toka Leya Camp	88
Tubu Tree Camp	28
Vumbura Plains	22
Xigera Camp	32
Zarafa Camp	39

EXPLORATIONS

Botswana Summer Encounter	99
Diverse Namibia	103
Green Desert Expedition	100
Landscapes of Malawi	105
Mana Canoe Trail	107
Migration Routes	98
Pafuri Walking Trail	106
Rift Valley Explorer	104
Selinda Canoe Trail	101
The Great Namibian Journey	102
The Great Wilderness Journey	97

Photographers list: Alistair Berg, Andrew Howard, Anthony Grote, Brett Wallington, Brian Rode, Bruce Simpson, Cardo Kleberg, Cathy Kays, Caroline Culbert, Clive Bester, Clive Dreyer, Colin Bell, Dana Allen, Daniel Myberg, Dave Hamman, Dave van Smeerdijk, Derek De La Harpe, Flip Stander, Frank Weitzer, Gerhard Thirion, Grant Atkinson, Gregg Hughes, James Gifford, Kate Potgieter-Vos, Kevin Van Breda, Lets Kamogelo, LIFE, Martin Benadie, Michael Poliza, Mike Myers, Nick Aldridge, Olwen Evans, Russel Friedman, Sue Snyman.

If we have left anyone out, this has not been intentional and we apologise.

READ MORE ABOUT US...

ONLINE



www.wilderness-safaris.com



www.wilderness-collection.com



www.wildernesstrust.com



www.childreninthewilderness.com



www.wilderness-the4cs.com



www.we-are-wilderness.com



www.facebook.com/wilderness.friends



www.twitter.com/wearewilderness

IN PRINT

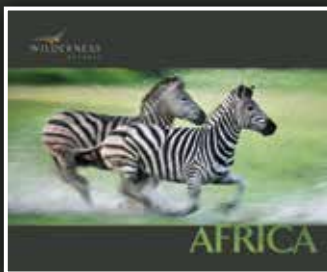

Wilderness Safaris – Africa

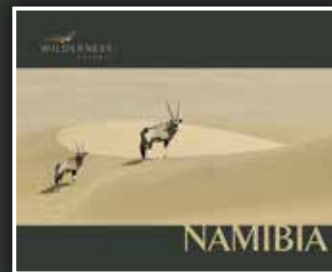

Wilderness Safaris – Namibia



Wilderness Safaris – Zimbabwe,
Zambia & Malawi



Wilderness Safaris – Botswana



The Wilderness Collection



Annual Report
Wilderness Wildlife Trust
Children in the Wilderness



The Wilderness Book
Volume 1



The Wilderness Book
Volume 2



www.wilderness-safaris.com

Wilderness Safaris
EST. 1983
30
YEARS

Printed on sustainably sourced paper. Please recycle. 